





CONNECTORS & FITTINGS

for Low Voltage Insulated Overhead Lines

Table of contents

| | | |
|------------|--|----|
| | Introduction..... | 4 |
| | Low Voltage Insulated Overhead Lines..... | 4 |
| I | Tap-off connectors | |
| |  | |
| | Piercing connector systems..... | 8 |
| | Waterproof insulation piercing connectors..... | 9 |
| | Insulation piercing connectors for connections to bare overhead..... | 10 |
| | Insulation piercing connectors for connections to cables..... | 11 |
| | Parallel groove clamps for bare neutral messenger and grounding..... | 12 |
| II | Inline connectors and lugs | |
| |  | |
| | Waterproof pre-insulated mechanical connectors..... | 16 |
| | Waterproof pre-insulated hexagonal compression connectors..... | 17 |
| | Waterproof pre-insulated hexagonal compression lugs..... | 20 |
| | Complete termination and connection kits with mechanical lugs and connectors..... | 22 |
| III | Connection and insulation accessories | |
| |  | |
| | Heat-shrinkable sealing breakouts with 2 to 5 fingers..... | 26 |
| | Heat-shrinkable sealing, marking and protection tubing..... | 27 |
| | Sealing end caps..... | 28 |
| | Repair sleeves and tapes..... | 29 |
| | Fuse cutout for services line..... | 31 |
| | Short-circuiting and earthing adapter and equipment..... | 32 |

Tap-off
connectorsInline
connectorsConnection
and
insulation
accessories

IV Anchoring and suspension



Anchor and suspension clamps for

| | |
|--|----|
| Service cables..... | 36 |
| Self supporting LV-ABC lines..... | 38 |
| LV-ABC lines with insulated neutral messenger..... | 40 |

Anchor and suspension accessories

| | |
|--|----|
| Wall mounted saddles and cable ties..... | 42 |
| Steel straps and protection devices..... | 43 |
| Hooks, brackets and bolts..... | 44 |

Anchoring
and
suspension

V Installation tools and equipment



Tools and equipment for

| | |
|--|----|
| Setting up LV-ABC lines..... | 50 |
| Installation of stainless steel straps and cable ties..... | 52 |
| Connecting LV-ABC lines..... | 53 |
| Compression connection of LV-ABC lines..... | 54 |

Installation
tools and
equipment

Appendix

Dimensions of LV-ABC cables according to HD 626

| | |
|---|-----------|
| Lines with insulated neutral messenger..... | 60 |
| Self-supporting lines..... | 61 |
| Lines with bare neutral messenger..... | 62 |
| Reference table | 63 |

Appendix

Introduction

Low Voltage Insulated Overhead Lines (LV-Aerial Bundled Conductor System)



TE Connectivity was one of the first to pioneer the connection, anchoring and suspension of low-voltage insulated overhead systems since its first installations in the mid 1950's. Since then, our continuous efforts in research and development have led to state of the art our product lines, meeting the demands of modern network design, operation and maintenance. Our products are successfully employed by utilities around the world including artic, desert and tropical climatic extremes. With TE Connectivity piercing connectors service lines can be connected to live lines with maximum safety to linemen.

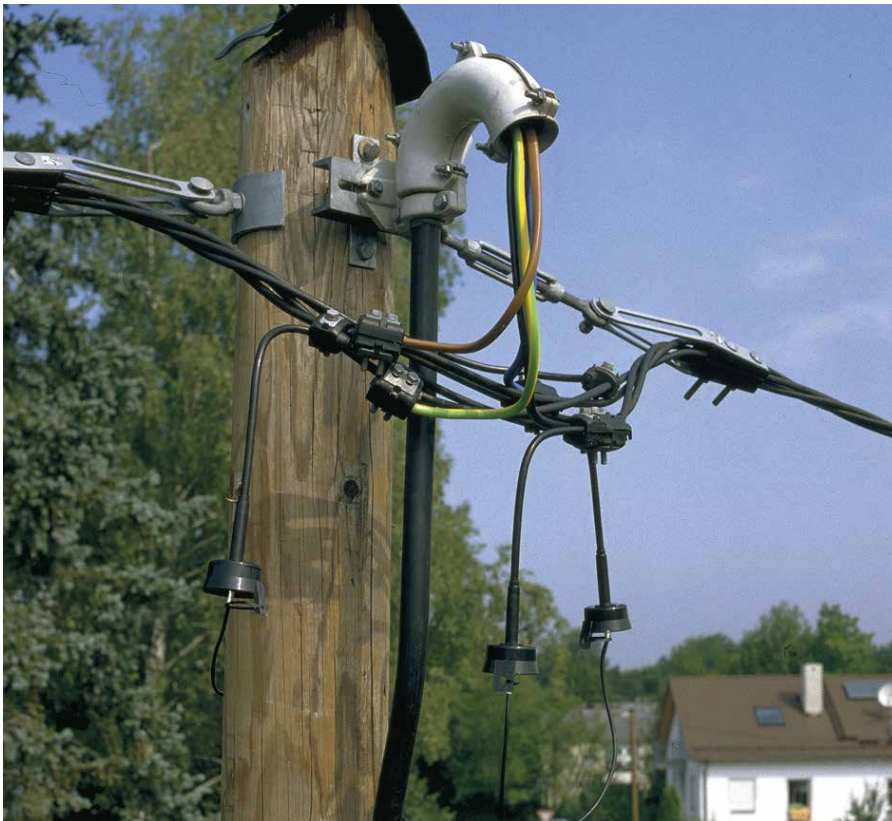

The 3 main types of LV-ABC according to European Standard HD 626

Our anchor and suspension clamps are designed and tested to fit to majority types of cables according to European Standard HD 626, regardless if cables are insulated with XLPE, PE or PVC. The products are tested according to national specifications such as NFC, VDE, BS, ESI and where possible in accordance to CENELEC EN 50483.

Self-supporting LV-ABC lines

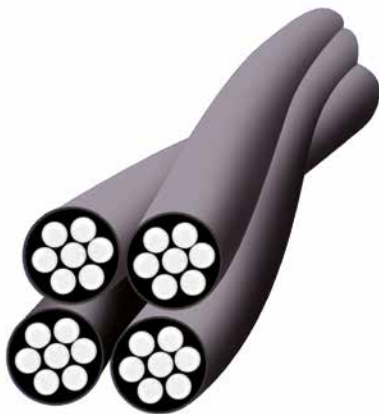

The self-supporting system is composed of 4 insulated aluminium conductors. Mechanical strength and nominal cross section of all 4 conductors are identical. The system can consist of additional 1 or 2 insulated aluminium conductors with cross sections of 16 mm² or 25 mm² as pilot wire or for street lighting.

When straining the line, all 4 conductors are equally loaded.

The service lines of all 3 LV-ABC systems are usually also of the self-supporting type, composed of 2 to 4 factory bundled insulated aluminium conductors with cross sections of 16 mm², 25 mm² or 35 mm².

LV-ABC lines with insulated neutral messenger

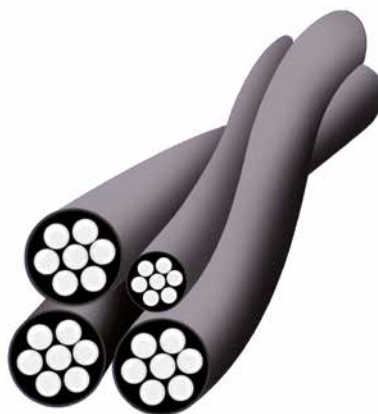

LV-ABC line with insulated neutral messenger wire, also referred to as "French System", is composed of 3 insulated aluminium phase conductors and 1 neutral messenger of aluminium alloy (mostly Aldrey) also with insulation. The system can consist of additional 1 or 2 insulated aluminium conductors with cross sections of 16 mm² or 25 mm² as pilot wire or for street lighting.

Mechanical strength and nominal cross section of the 3 phase conductors are identical. The neutral conductor is at the same time the suspension unit having a higher mechanical strength. When straining the line, only the neutral conductor, as suspension unit, is loaded.

LV-ABC lines with bare neutral messenger

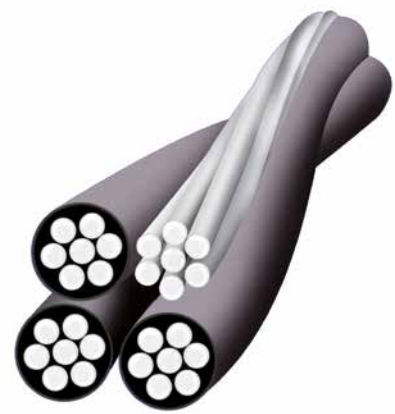

LV-ABC line with bare neutral messenger wire, also referred to as "Finnish System", is composed of 3 insulated aluminium phase conductors and 1 neutral messenger of aluminium alloy without insulation. The system can consist of additional 1 or 2 insulated aluminium conductors with cross sections of 16 mm² or 25 mm² as pilot wire or for street lighting.

Mechanical strength and nominal cross section of the 3 phase conductors are identical. The neutral conductor is at the same time the suspension unit having a higher mechanical strength. When straining the line, only the neutral conductor, as suspension unit, is loaded.

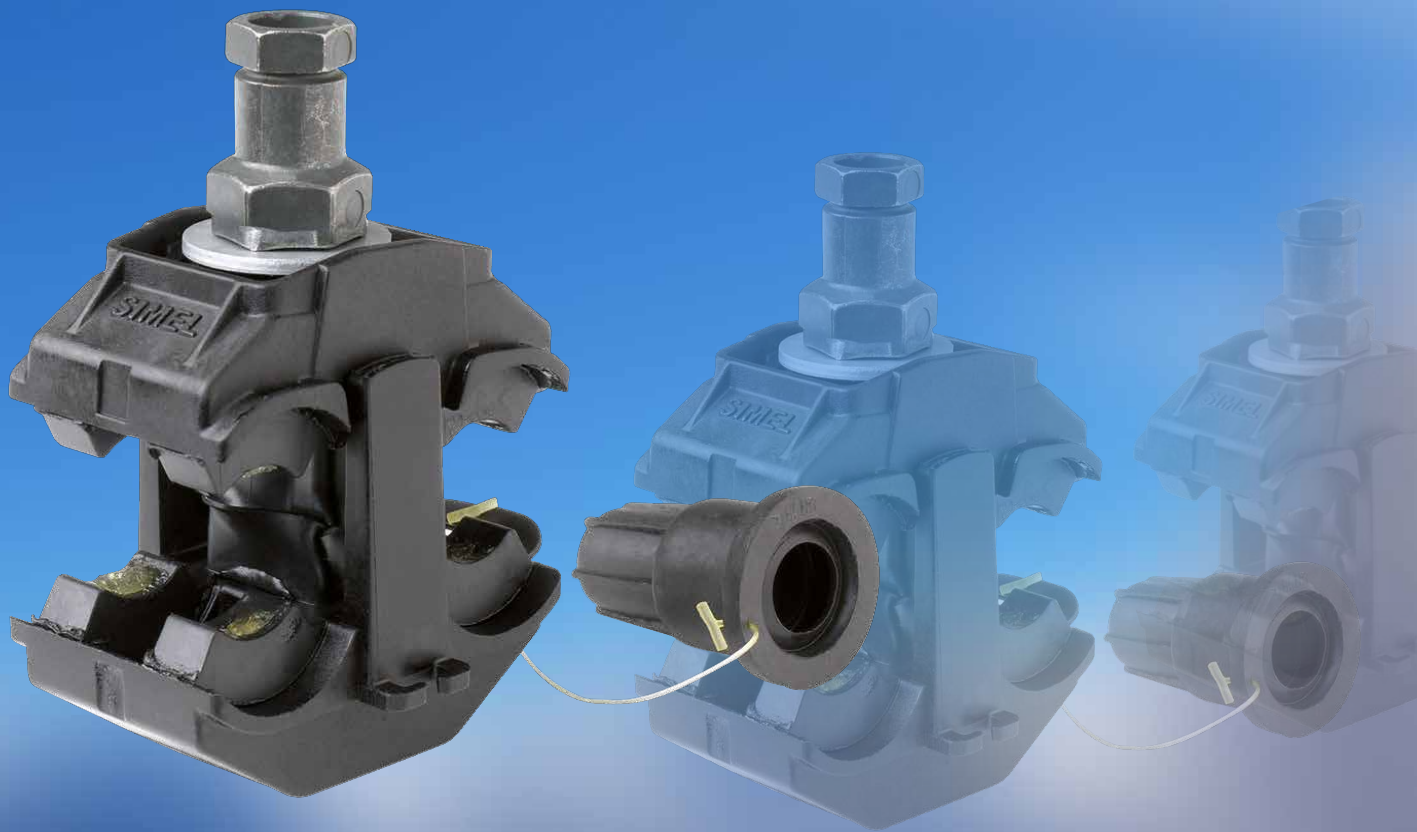



Chapter I

Tap-off connectors

| | |
|--|----|
| Piercing connector systems | 8 |
| Waterproof insulation piercing connectors | 9 |
| Insulation piercing connectors for connections to bare overhead | 10 |
| Insulation piercing connectors for connections to cables | 11 |
| Parallel groove clamps for bare neutral messenger and grounding..... | 12 |

Piercing Connector Systems

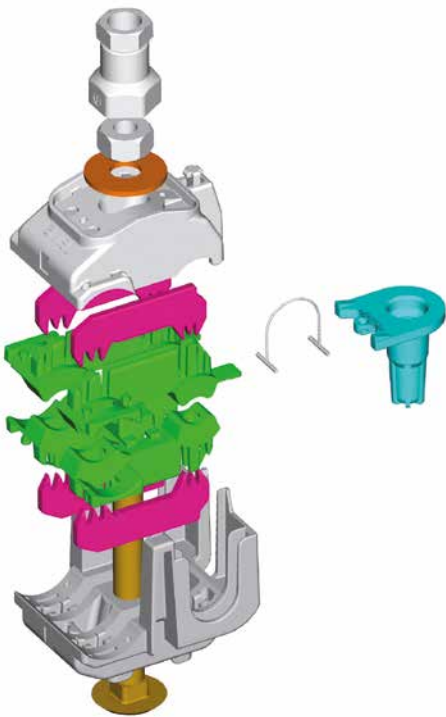

All our connectors are designed and tested to fit to majority types of cables made in accordance with the European Standard HD 626, regardless if cables are insulated with XLPE, PE or PVC. The products are tested according to national specifications such as NFC, VDE, BS, ESI and where possible in accordance to CENELEC EN 50483-4.

These standards include tests to verify reliable operation even in the harshest environments:

- designed for installation from $-20\text{ }^{\circ}\text{C}$ up to $+50\text{ }^{\circ}\text{C}$,
- operation experience with temperatures ranging from $-60\text{ }^{\circ}\text{C}$ up to $+60\text{ }^{\circ}\text{C}$,
- no limitation of mechanical loads for main and branch conductors,
- shear head forces are adapted to the required contact forces for each application (main, service, lightning),
- voltage withstand to 6 kV in a 30 cm waterbath,
- no change in contact resistance and temperature after overloads and load cycling,
- voltage withstand to 6 kV after heavy weathering exposure (UV-light, humidity and temperature cycling),
- corrosion resistance of metal parts proven in salt fog chamber and wet SO_2 gas chamber.

Installation process engineered for long-term reliability

Before installation

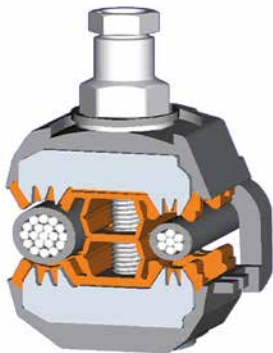

Connector easily positioned over cables, no loose parts can fall to ground. The correct position of the branch conductor can be felt inside the end cap.

During installation



Contact blades pierce the insulation and reliably contact the conductors. The tightening screw is insulated from the contact blades thus providing maximum safety for the installer even during live line installations.

After shear head breaking



The shear head ensures that conductors are not damaged by too strong forces. The long neck prevents the head from hasty shearing off by naturally applied cantilever loads on the tightening tool. The seals firmly conform to the insulation to prevent any moisture ingress.

Waterproof insulation piercing connectors – test voltage 6 kV in water

Tap-off connectors

Application

The waterproof insulation piercing connectors are suitable for majority types of LV ABC conductors as well as connections to service and lighting cable cores.

When tightening the bolts, the teeth of the contact plates penetrate the insulation and establish a perfect contact. The bolts are tightened until the heads shear off. Stripping of insulation is avoided.

Features

- Tested for watertightness at a voltage of 6 kV for 30 min in a waterbath (NFC 33020, EN 50483-4 class 1)
- Potential free tightening bolts allow safe installations on live lines
- Suitable for aluminium and copper conductors
- Long neck 13 mm shear head nut ensuring reliable installations
- Exceeds requirements according to NFC 33020 and EN 50483-4
- Components not losable, end cap attached to body

- Insulation material made of weather and UV resistant glass fibre reinforced polymer
- Contact plates made of aluminium or copper, bolt made of steel with Geomet (Chromium free) protection
- Designed that conductor breaking loads exceed cable system requirements: 80 % for self-supporting system 90 % for insulated neutral conductor and 60 % for phase conductors for system with insulated neutral messenger



Type: EP, P2X, P3X, P4X



Type: KZ 2-150 2B



Type: P31F

Simultaneous piercing of main and branch conductor

| Ordering description | Application range (mm ²) | | Bolt | Torque (Nm) | Weight (kg/100 pcs) |
|---------------------------------------|--------------------------------------|--------------|--------|-------------|---------------------|
| | Main | Tap | | | |
| for main to service connection | | | | | |
| EP35-13 | 2.5 – 35 | 1.5 – 6 | 1 x M6 | 7 | 5.0 |
| EP95-13 | 6 – 95 | 1.5 – 10 | 1 x M6 | 7 | 5.0 |
| P2X 95 Mk2 | 16 – 95 | 4 – 35 (50°) | 1 x M8 | 11 | 10.8 |
| EP120-13 | 16 – 120 | 1.5 – 6 | 1 x M8 | 8 | 5.4 |
| P2X 150 | 50 – 150 | 6 – 35 (50°) | 1 x M8 | 11 | 12.0 |
| for main to main connections | | | | | |
| P2X 95 Mk2 | 16 – 35 | 16 – 35 | 1 x M8 | 11 | 10.8 |
| P3X 95 | 25 – 95 | 25 – 95 | 1 x M8 | 18 | 16.0 |
| P4X 120D | 25 – 120 | 25 – 120 | 2 x M8 | 18 | 34.0 |
| P4X 150D | 50 – 150 | 50 – 150 | 2 x M8 | 18 | 34.0 |

* Fits up to this conductor size, but current rating I_{max} of connector (138 A according to HD 626S1 part 6E) is lower than possible cable ratings.

Independent connection of main (piercing) and branch conductor (strippable)

| Ordering description | Application range (mm ²) | | Bolt | Torque (Nm) | Weight (kg/100 pcs) |
|--|--------------------------------------|------------|----------------|-------------|---------------------|
| | Main | Tap | | | |
| for main to 2 service connections (Bp-piercing tap side, B-strippable tap side) | | | | | |
| KZ 2-150 2B | 25 – 150 | 2 x 6 – 35 | 1 x M8/2 x M8 | 11/8 | 23.0 |
| KZ 2-150 2Bp | 25 – 150 | 2 x 6 – 35 | 1 x M8/2 x M8 | 11/10 | 23.0 |
| for main to main connections (strippable tap side) | | | | | |
| P31F | 35 – 150 | 35 – 70 | 1 x M8/1 x M10 | 18/10 | 21.6 |

* Fits up to this conductor size, but current rating I_{max} of connector (213 A according to HD 626S1 part 6E) is lower than possible cable ratings.

NOTE Possibility to disconnect and reconnect the tap line (only stripping version) without removal of the main side.

Insulation piercing connectors for connections to bare overhead

Application

The connectors allow the transition between bare lines (aluminium or copper) and insulated LV ABC lines.

The version with simultaneous connection of bare main and insulated tap conductor includes piercing and a waterproof seal of the tap conductor.

The second version with independent connection requires the tap conductor to be stripped. The bolts (13 mm) are tightened until the heads shear off.

Features

- Suitable for aluminium and copper conductors
- Groove in contact area for bare conductor fits also for small wires
- Potential free tightening bolts allow safe installations on life lines
- Exceeds requirements according to NFC 33020 and EN 50483-4
- Components not losable, end cap attached to body
- Insulation material made of weather and UV resistant glass fibre reinforced polymer
- Contact plates made of tinned copper, bolt made of steel with Geomet (Chromium free) protection



Type: P2X 95 Mk2, EP95-13



Type: P3B120, P2B100 U Mk 2



Type: KZ31-70 CNA

For bare main (Al/Cu) to insulated service connections

| Ordering description | Application range (mm ²) | | Bolt | Torque (Nm) | Weight (kg/100 pcs) |
|---|--------------------------------------|------------|--------|-------------|---------------------|
| | Bare | Insulated | | | |
| For bare main (Al/Cu) to insulated service connections | | | | | |
| EP95 – 13 | 16 – 95 | 1.5 – 10 | 1 x M6 | 7 | 5.0 |
| P2X 95 Mk2* | 16 – 95 | 4 – 35 | 1 x M8 | 11 | 10.8 |
| P2B100 U Mk2 | 7 – 100 | 4 – 35(50) | 1 x M8 | 11 | 13.5 |
| For bare main (Al/Cu) to insulated main connections | | | | | |
| P3B120 | 7 – 120 (150) mm ² | 25 – 95 | 1 x M8 | 18 | 17.0 |

* Connector of type P2X can only be used for connections between aluminium conductors.

NOTE Equivalent to a diameter range of 4.5 to 12 mm.

Independent connection of main (bare) and branch conductor (strippable)

| Application range (mm ²) | | Ordering description | Bolt | Torque (Nm) | Weight (kg/100 pcs) |
|--------------------------------------|-----------|----------------------|----------------|-------------|---------------------|
| Bare | Insulated | | | | |
| 22 – 75 Al* | 35 – 70 | KZ31-70 CNA | 1 x M8/1 x M10 | 11/10 | 24.0 |
| 7 – 48 Cu | 35 – 70 | KZ31-70 CNU | 1 x M8/1 x M10 | 11/10 | 24.0 |

* Equivalent to a diameter range of 6 to 11 mm.

NOTE Possibility to disconnect and reconnect the tap line without removal of the main side. CNA only for bare main aluminium conductors. CNU only for bare main copper conductors.

Insulation piercing connectors for connections to cables

Application

All piercing connectors of EP and PX type (see page 9) can be used as a connection between LV-ABC and service or main cables.

The DZ6 connector is designed for connection of cables with large cross sections to insulated LV ABC lines. When tightening the bolts, the teeth of the contact plates penetrate the insulation and establish a perfect contact. The bolts (wrench size 17 mm) are tightened until the heads shear off. Stripping of insulation is avoided and the cable end is sealed with a cap.

Features

- Suitable for aluminium and copper conductors
- Potential free tightening bolts allow safe installations on life lines
- Connectors type DZ6 exceed requirements according to UL486 and EATS 43-14, including 4 kV voltage withstand test in air
- Connector teeth are factory greased and covered with a rubber seal to retard water entry and corrosion
- Components not losable, end cap attached to body

- Insulation material made of weather and UV resistant glass fibre reinforced polymer
- Contact plates made of tinned copper, bolt made of steel with Geomet (Chromium free) protection

For inline connections of LV-ABC to cables see section "Complete connection kits" on 35.

For cable terminations and core protection tubing see pages 25 and 26.



Type: DZ6 UL-F



Type: P3X 95



Type: P2X 95 Mk2, EP95-13

Simultaneous piercing of main (insulated LV-ABC) and branch (cable core) conductor

| Ordering description | Application range (mm ²) | | Bolt | Torque | Weight |
|----------------------|--------------------------------------|-----------------|---------|--------|--------------|
| | LV-ABC | Cable conductor | | (Nm) | (kg/100 pcs) |
| EP95-13 | 16 – 95 | 1.5 – 10 | 1 x M6 | 7 | 5.0 |
| P2X 95 Mk2 | 16 – 95 | 4 – 35 | 1 x M8 | 11 | 10.8 |
| P3X 95 | 25 – 95 | 25 – 95 | 1 x M8 | 18 | 16.0 |
| DZ6 UL-F-CHINA-N | 25 – 120 (150*) | 120 – 240 | 1 x M10 | 40 | 30.0 |

* Fits up to this conductor size, but current rating I_{max} of connector (300 A according to HD 626S1 part 6E) is lower than possible cable rating.

Parallel groove clamps for bare neutral messenger and grounding

Application

Designed to connect two parallel bare conductors. Conductors can be aluminium alloy or aluminium steel reinforced.

Features

- Exceed requirements according to VDE 0210 and VDE 0212
- Pressure pad ensuring uniform pressure along the clamp
- Cross-grooved clamp channels of universal clamp type improve mechanical pullout strength and electrical contact
- Connector bodies made of corrosion resistant, high strength aluminium alloy AlMgSiF32
- Bolts and nuts made of hot dip galvanized steel 8.8.



Type: Al - Al

Application

Designed to connect two parallel bare conductors. Conductors can be aluminium alloy or aluminium steel reinforced for main and copper for tap side.

Features

- in addition to aluminium version:
- Hot compressed Cupal plate ensures good electrical contact and prevents corrosion
 - Cross-grooved clamp channels improve mechanical pullout strength and electrical contact
 - Spring washers maintain pressure even at dilatation caused by temperature changes



Type: Al - Cu

Application

Designed to connect two parallel bare conductors. Conductors can be copper stranded or solid.

Features

different from aluminium version:

- Connector bodies and bolts made of high strength electrolytic copper F60



Type: Cu - Cu

| Ordering description | Conductor cross section (mm ²) | | | Conductor diameter (mm) | | Bolt | Torque (Nm) | Weight (kg/100 pcs) |
|--|--|-------------------|----------|-------------------------|------------|---------|-------------|---------------------|
| | Al | Al/St, ACSR | Cu | Al | Cu | | | |
| Aluminium – Aluminium | | | | | | | | |
| HEL-3587 | 6 – 35 | 16/2.5 – 25/4 | – | 2.5 – 7.5 | – | 2 x M7 | 16 | 9.5 |
| HEL-3590 | 10 – 95 | 16/2.5 – 70/12 | – | 4.1 – 12.5 | – | 2 x M8 | 22 | 14.3 |
| HEL-3591 | 16 – 120 | 16/2.5 – 95/15 | – | 5.1 – 14.0 | – | 2 x M8 | 22 | 15.8 |
| HEL-3592 | 25 – 150 | 25/4 – 120/20 | – | 6.3 – 15.7 | – | 2 x M10 | 44 | 24.0 |
| HEL-3594 | 35 – 240 | 35/6 – 210/35 | – | 7.5 – 20.2 | – | 2 x M10 | 44 | 45.0 |
| Universal type for fixing of dead – ends, tap conductors and auxiliary conductors | | | | | | | | |
| HEL-3929 | 16 – 70 | 16/2.5 – 70/12(1) | – | 5.1 – 10.5 | – | 2 x M8 | 22 | 10.0 |
| HEL-3932 | 25 – 150 | 25/4 – 120/20(2) | – | 6.3 – 15.7 | – | 2 x M10 | 44 | 20.4 |
| Aluminium – Copper | | | | | | | | |
| HEL-3920 | 16 – 95 | 16/2.5 – 50/8 | 1.5 – 10 | 5.1 – 11.7 | 1.5 – 5.1 | 1 x M8 | 22 | 6.0 |
| HEL-3919 | 16 – 70 | 16/2.5 – 70/12 | 6 – 50 | 5.1 – 11.7 | 2.7 – 9.0 | 1 x M8 | 22 | 6.0 |
| HEL-3909 | 16 – 95 | 16/2.5 – 70/12 | 6 – 50 | 5.1 – 12.5 | 2.7 – 9.0 | 2 x M8 | 22 | 11.5 |
| HEL-3911 | 25 – 150 | 25/4 – 120/20 | 10 – 95 | 6.3 – 15.7 | 5.1 – 12.5 | 2 x M8 | 22 | 15.0 |
| HEL-3915 | 35 – 300 | 35/6 – 265/35 | 35 – 240 | 7.5 – 22.5 | 7.5 – 20.2 | 3 x M10 | 44 | 68.0 |
| Copper – Copper | | | | | | | | |
| HEL-3005 | – | – | 2.5 – 16 | – | 1.8 – 5.1 | 1 x M5 | 6 | 2.8 |
| HEL-3006 M6 | – | – | 4 – 25 | – | 2.3 – 6.3 | 1 x M6 | 8 | 4.6 |
| HEL-3007 | – | – | 6 – 35 | – | 2.7 – 7.5 | 1 x M7 | 14 | 6.5 |
| HEL-3009 | – | – | 6 – 70 | – | 2.7 – 10.5 | 1 x M8 | 20 | 11.7 |
| HEL-3029 | – | – | 6 – 70 | – | 2.7 – 10.5 | 2 x M8 | 20 | 19.8 |
| HEL-3030 | – | – | 16 – 95 | – | 5.1 – 12.5 | 2 x M8 | 20 | 26.5 |
| | – | – | 16 – 150 | – | 5.1 – 15.7 | 2 x M10 | 39 | 43.0 |

NOTE

- 1) Use 2 clamps for dead – ends and auxiliary conductors of 50/8 and 70/12.
- 2) Use 2 clamps for dead – ends for 70/12 and above and for auxiliary conductors with strain above 90 N/mm².

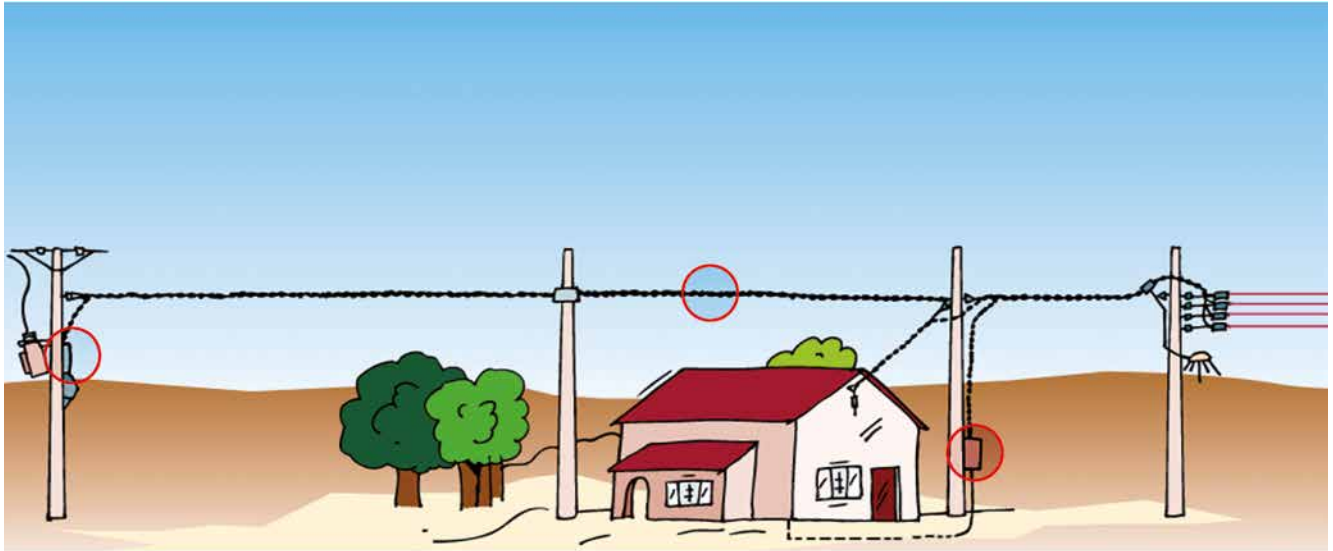





Chapter II Inline connectors and lugs

| | |
|--|----|
| Waterproof pre-insulated mechanical connectors..... | 16 |
| Waterproof pre-insulated hexagonal compression connectors..... | 17 |
| Waterproof pre-insulated hexagonal compression lugs..... | 20 |
| Complete termination and connection kits with mechanical lugs and connectors..... | 22 |

Waterproof pre-insulated mechanical connectors for service cables

Application

These waterproof insulated mechanical connectors are suitable for all types of LV-ABC conductors as well as connections to service and lighting cable cores. They are used when a customer service line is changed or reconnect to a customer after payment. End cap is included to seal open sides. The bolts (13 mm) are being tightened until the heads shear off. Available with a piercing contact and as second version which requires stripping of the insulation.

Features

- Suitable for aluminium and copper conductors, solid and stranded
- Stripping version can be installed and removed under load (max. 90 A)
- Polymeric tightening bolts allow safe installations on hot lines
- Tested for watertightness at a voltage of 6 kV for 30 min in a waterbath (NFC 33020, EN 50483-4 class 1)
- Exceeds requirements according to NFC 33020, NFC 33021 and NFC 20 540
- Components not losable, end cap attached to body
- Stripping version re-openable, piercing version not re-openable
- Insulation material made of weather and UV resistant glass fibre reinforced polymer



Type: piercing version



Type: stripping version



| Ordering description | Cross section (mm ²) | | Type | I _{max} * (A) | Torque (Nm) | Weight (kg/100 pcs) |
|----------------------|----------------------------------|------|---------------------|---------------------------|----------------|------------------------|
| | min. | max. | | | | |
| BPC 35 - 35 | 4 | 35 | stripping/stripping | 90 | 10 | 8.5 |
| BPC 35 - P35 | 4 | 35 | stripping/piercing | 90 | 10 | 8.5 |
| BPC P35 - P35 | 4 | 35 | piercing/piercing | – | 10 | 8.5 |
| BPC P50 | 4 | 50 | piercing/piercing | – | 10 | 8.5 |

* Max. current for connection under load.

Waterproof pre-insulated hexagonal compression connectors for service cables

Application

These pre-insulated connectors are suitable for insulated stranded aluminium conductors. Stripped cables are inserted up to the block in the connector. Crimping according to the marks with crimping die size E140 over the insulation. The electrical contact and the sealing by the elastomeric ring are achieved during the crimp process. Uniform connector length of 70 mm.

Features

- MJPB suitable for stranded aluminium conductors up to 35 mm² and stranded copper conductors up to 16 mm²
- MJPBAS suitable for stranded aluminium conductors to solid aluminium conductors
- Mechanical strength of 50 % of cable breaking load
- Tested for water tightness at a voltage of 6 kV for 30 min in a water bath
- One die size E140 for all connector sizes (tools and dies see pages 51 and 53)
- Exceeds requirements according to NFC 33021 and EN 50483-4

- A colour code of elastomeric sealing ring allows an easy identification of the cross sections
- Inner aluminium sleeve filled with contact grease
- Insulation material made of weather and UV resistant polymer



Type: MJPB, MJPBAS



Type: MJPB 10-16 (sectional view)

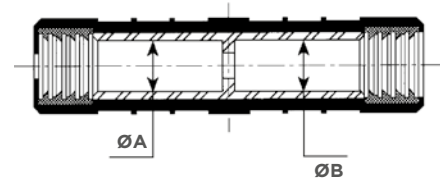

MJPB for stranded conductors

| Ordering description | Cross section (mm ²) | | Colour code A/B | Dimensions (mm) | | Weight (kg/100 pcs) |
|----------------------|----------------------------------|------------|-----------------|-----------------|-----|---------------------|
| | stranded A | stranded B | | ØA | ØB | |
| MJPB 04-16 | 4 | 16 | ivory/blue | 2.7 | 5.3 | 2.5 |
| MJPB 06 | 6 | 6 | brown | 3.3 | 3.3 | 2.5 |
| MJPB 06-10 | 6 | 10 | brown/green | 3.3 | 4.3 | 2.5 |
| MJPB 06-16 | 6 | 16 | brown/blue | 3.3 | 5.3 | 2.5 |
| MJPB 06-25 | 6 | 25 | brown/orange | 3.3 | 6.5 | 2.5 |
| MJPB 06-35 | 6 | 35 | brown/red | 3.3 | 8.0 | 2.5 |
| MJPB 10 | 10 | 10 | green | 4.3 | 4.3 | 2.5 |
| MJPB 10-16 | 10 | 16 | green/blue | 4.3 | 5.3 | 2.5 |
| MJPB 10-25 | 10 | 25 | green/orange | 4.3 | 6.5 | 2.5 |
| MJPB 10-35 | 10 | 35 | green/red | 4.3 | 8.0 | 2.5 |
| MJPB 16 | 16 | 16 | blue | 5.3 | 5.3 | 2.5 |
| MJPB 16-25 | 16 | 25 | blue/orange | 5.3 | 6.5 | 2.5 |
| MJPB 16-35 | 16 | 35 | blue/red | 5.3 | 8.0 | 2.5 |
| MJPB 25 | 25 | 25 | orange | 6.5 | 6.5 | 2.5 |
| MJPB 25-35 | 25 | 35 | orange/red | 6.5 | 8.0 | 2.5 |
| MJPB 35 | 35 | 35 | red | 8.0 | 8.0 | 2.5 |

MJPBAS for stranded to solid conductors

| Ordering description | Cross section (mm ²) | | Colour code A/B | Dimensions (mm) | | Weight (kg/100 pcs) |
|----------------------|----------------------------------|---------|-----------------|-----------------|-----|---------------------|
| | stranded A | solid B | | ØA | ØB | |
| MJPBAS 10-25M | 10 | 25 | green/orange | 4.3 | 5.9 | 2.5 |
| MJPBAS 10-35M | 10 | 35 | green/red | 4.3 | 6.9 | 2.5 |
| MJPBAS 16-16M | 16 | 16 | blue/blue | 5.3 | 4.5 | 2.5 |
| MJPBAS 16-25M | 16 | 25 | blue/orange | 5.3 | 5.9 | 2.5 |
| MJPBAS 16-35M | 16 | 35 | blue/red | 5.3 | 6.9 | 2.5 |
| MJPBAS 25-16M | 25 | 16 | orange/blue | 6.5 | 4.8 | 2.5 |
| MJPBAS 25-25M | 25 | 25 | orange/orange | 6.5 | 5.9 | 2.5 |
| MJPBAS 25-35M | 25 | 35 | orange/red | 6.5 | 6.9 | 2.5 |
| MJPBAS 35-35M | 35 | 35 | red/red | 8.0 | 6.9 | 2.5 |

Waterproof pre-insulated hexagonal compression connectors

Application

These pre-insulated connectors are suitable for insulated stranded aluminium conductors. Three connector versions are available to meet the mechanical load requirements for self-supporting system and systems with a neutral messenger.

Stripped cables are inserted up to the block in the connector. Crimping according to the marks with appropriate crimping die over the insulation. The electrical contact and the sealing by the elastomeric ring are achieved during the crimp process. Uniform connector length of 100 mm, except for neutral messengers 170 mm.

Features

- Suitable for stranded aluminium conductors
- Tested for water tightness at a voltage of 6 kV for 30 min in a waterbath (NFC 33020, EN 50483-4 class 1)
- Only two crimping die sizes (E173, E215) cover complete connector range (tools and dies see pages 51 and 52)
- Exceeds requirements according to EN 50483-4 class 1 and NFC 33021
- A colour code of elastomeric sealing ring allows an easy identification of the cross sections
- Inner aluminium sleeve filled with contact grease
- Insulation material made of weather and UV resistant polymer

Mechanical load withstand of connectors:

- For conductors of self-supporting system: 85 % of conductor breaking load
- For systems with neutral messenger: 60 % of breaking load of phase conductor 95 % of breaking load of insulated neutral conductor



Type: MJPT

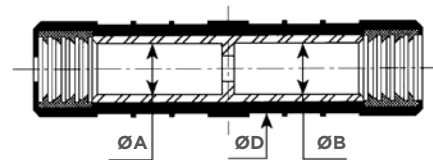

| | Conductor cross section (mm ²) | Colour code A/B | Dimensions (mm) | | | Crimp die size | Weight (kg/100 pcs) |
|--|--|-----------------|-----------------|------|----|----------------|---------------------|
| | | | ØA | ØB | ØD | | |
| For self supporting LV-ABC systems | | | | | | | |
| MJPT 16 | 16 | blue | 5.5 | 5.5 | 20 | E173 | 5.5 |
| MJPT 25 Alus | 25 | orange | 6.5 | 6.5 | 20 | E173 | 5.5 |
| MJPT 35 Alus | 35 | red | – | – | – | E173 | 5.5 |
| MJPT 50 Alus | 50 | yellow | 9.0 | 9.0 | 20 | E173 | 5.0 |
| MJPT 70 Alus | 70 | white | 10.5 | 10.5 | 20 | E173 | 4.5 |
| MJPT 95 Alus | 95 | grey | 12.2 | 12.2 | 25 | E215 | 7.5 |
| MJPT 120 Alus | 120 | pink | 14.2 | 14.2 | 25 | E215 | 7.5 |
| For phase conductors of LV-ABC systems with neutral messenger | | | | | | | |
| MJPT 16 | 16 | blue | 5.5 | 5.5 | 20 | E173 | 5.5 |
| MJPT 25 | 25 | orange | 6.5 | 6.5 | 20 | E173 | 5.0 |
| MJPT 35 | 35 | red | 8.0 | 8.0 | 20 | E173 | 5.0 |
| MJPT 35-25 | 35 – 25 | red/orange | 8.0 | 6.5 | 20 | E173 | 5.0 |
| MJPT 50 | 50 | yellow | 9.0 | 9.0 | 20 | E173 | 5.0 |
| MJPT 50-25 | 50 – 25 | yellow/orange | 9.0 | 6.5 | 20 | E173 | 5.0 |
| MJPT 50-35 | 50 – 35 | yellow/red | 9.0 | 8.0 | 20 | E173 | 5.0 |
| MJPT 70 | 70 | white | 10.5 | 10.5 | 20 | E173 | 4.5 |
| MJPT 70-35 | 70 – 35 | white/red | 10.5 | 8.0 | 20 | E173 | 4.5 |
| MJPT 70-50 | 70 – 50 | white/yellow | 10.5 | 9.0 | 20 | E173 | 4.5 |
| MJPT 95 | 95 | grey | 12.2 | 12.2 | 20 | E173 | 4.0 |
| MJPT 95-35 | 95 – 35 | grey/red | 12.2 | 8.0 | 20 | E173 | 4.5 |
| MJPT 95-50 | 95 – 50 | grey/yellow | 12.2 | 9.0 | 20 | E173 | 4.0 |
| MJPT 95-70 | 95 – 70 | grey/white | 12.2 | 10.5 | 20 | E173 | 4.0 |
| MJPT 120 D25 | 120 | pink | 14.2 | 14.2 | 25 | E215 | 8.5 |
| MJPT 150 | 150 | violet | 15.5 | 15.5 | 25 | E215 | 8.0 |
| MJPT 150-70 | 150 – 70 | violet/white | 15.5 | 10.5 | 25 | E215 | 9.0 |
| MJPT 150-95 | 150 – 95 | violet/grey | 15.5 | 12.2 | 25 | E215 | 9.0 |
| For insulated neutral conductors of LV-ABC systems with neutral messenger | | | | | | | |
| MJPT 54 | 54.6 | black | 10.0 | 10.0 | 20 | E173 | 8.0 |
| MJPT 70N | 70 | white | 10.5 | 10.5 | 20 | E173 | 8.0 |
| MJPT 70N-54 | 70 – 54.6 | white/black | 10.5 | 10.0 | 20 | E173 | 8.0 |

Waterproof pre-insulated hexagonal compression lugs

Application

These pre-insulated lugs are suitable for insulated stranded aluminium conductors. Stripped cables are inserted up to the end. Crimping according to the marks with appropriate crimping die size over the insulation. The electrical contact and the sealing by the elastomeric ring are achieved during the crimp process. Available with aluminium palm (CPTA) and as bimetallic lug with a copper palm (CPTAU).

Features

- Suitable for stranded aluminium conductors
- Mechanical strength achieved is 50% of cable breaking load
- Tested for water tightness at a voltage of 6 kV for 30 min in a waterbath
- Three die sizes (E140, E173, E215) for all connector sizes (tools and dies see pages 51 and 52)
- Exceeds requirements according to EN 50483-4 class 1 and NFC 33021
- A colour code of elastomeric sealing ring allows an easy identification of the cross sections
- Inner aluminium sleeve filled with contact grease
- Insulation material made of weather and UV resistant polymer



Type: CPTA



Type: CPTAU

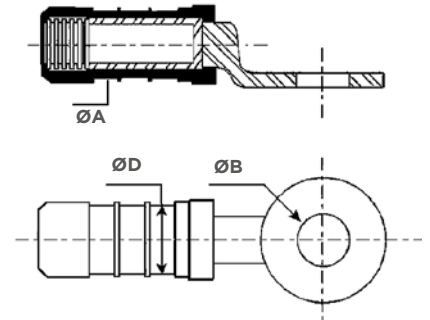

Waterproof compression lugs

| Ordering description | Cross section (mm ²) | Colour code | Dimensions (mm) | | | Crimp die size | Weight (kg/100 pcs) |
|---------------------------------------|----------------------------------|-------------|-----------------|------|----|----------------|---------------------|
| | | | ØA | ØB | ØD | | |
| With aluminium palms | | | | | | | |
| CPTA 35 | 35 | red | 8.0 | 16.0 | 20 | E173 | 7.0 |
| CPTA 50 | 50 | yellow | 9.0 | 16.0 | 20 | E173 | 7.0 |
| CPTA 54 | 54 | black | 10.0 | 16.0 | 20 | E173 | 7.0 |
| CPTA 70 | 70 | white | 10.5 | 16.0 | 20 | E173 | 7.0 |
| CPTA 95 D20 | 95 | grey | 12.2 | 16.0 | 20 | E173 | 6.5 |
| CPTA 150-21 D20UK | 150 | violet | 15.5 | 21.0 | 20 | E173 | 7.0 |
| With copper palms (bimetallic) | | | | | | | |
| CPTAU 16 D16 | 16 | blue | 5.5 | 10.5 | 16 | E140 | 3.5 |
| CPTAU 25 D16 | 25 | orange | 6.5 | 10.5 | 16 | E140 | 3.0 |
| CPTAU 35 (trousse) | 35 | red | 8.0 | 12.8 | 20 | E173 | 7.0 |
| CPTAU 50 | 50 | yellow | 9.0 | 12.8 | 20 | E173 | 7.0 |
| CPTAU 54 | 54 | black | 10.0 | 12.8 | 20 | E173 | 7.0 |
| CPTAU 70 | 70 | white | 10.5 | 12.8 | 20 | E173 | 7.0 |
| CPTAU 95 | 95 | grey | 12.2 | 12.8 | 20 | E173 | 6.5 |
| CPTAU 120 D25 | 120 | pink | 14.2 | 12.8 | 25 | E215 | 13.0 |
| CPTAU 150 D25 | 150 | violet | 15.5 | 12.8 | 25 | E215 | 12.5 |

Waterproof compression lugs

| Ordering description | Dimensions (mm) |
|---------------------------|-----------------|
| | ØB |
| RONDELLE 30X10,5X2 -AL/CU | 10.5 |
| RONDELLE 30X13X2 -AL/CU | 12.8 |

Complete termination kits – bare mechanical lugs with sealing tubing

Application

These complete termination kits contain 4 pieces of mechanical lugs and 4 pieces of heat-shrinkable sealing tubing.

Included mechanical lugs are suitable for stranded or solid conductors made of either aluminium or copper. The cable insulation has to be stripped before the conductor is inserted into the lug. During an installation the bolts are being tightened with a regular spanner until the heads sheared off.

The reliable sealing between the lug and the conductor's insulation is achieved by supplied heat-shrinkable tubing. The tubing is resistant to UV-light and weathering and coated with hot-melt adhesive, which seals to all common plastics and metals.

Features

- Suitable for stranded and solid, round or sector shaped conductors
- Wide application ranges
- Lug bodies made of a high-tensile, tin-plated aluminium alloy
- Grooved internal surface of the conductor hole
- Lubricated shear bolts with predetermined shear torque made of special aluminium
- Exceeds requirements according to IEC 61238-1 class A
- Heat-shrinkable tubing, supplied with kit, ensures perfect sealing and electrical insulation



Type: SMOE-xxxx



Type: BLMT

| Ordering description | Cross section (mm ²) | Length of sealing tubing (mm) | Hexagon contact bolts | |
|----------------------|----------------------------------|-------------------------------|-----------------------|-------------------------|
| | | | Quantity (pc) | Width across flats (mm) |
| SMOE-82286 | 25 – 95 | 100 | 1 | 13 |
| SMOE-82287 | 35 – 150 | 150 | 1 | 17 |
| SMOE-82288 | 95 – 240 | 150 | 2 | 19 |

NOTE Termination kits contain 4 lugs with 13 mm diameter hole in palm and 4 heat-shrinkable, sealing tubing.

Complete connection kits – bare non-tension mechanical connectors with sealing tubing

Application

These complete connection kits contain 4 pieces of mechanical connectors and 4 pieces of heat-shrinkable sealing tubing. Included non-tension mechanical connectors are designed to connect LV ABC conductors between each other and to underground cable conductors.

The cable insulation has to be stripped before the conductor is inserted into the connector. During an installation the bolts are being tightened until the heads sheared off. The reliable sealing between the connector and the conductor's insulation is achieved by supplied heat-shrinkable tubing. The tubing is resistant to UV-light and weathering and coated with hot-melt adhesive, which seals to all common plastics and metals.

Features

- Suitable for stranded and solid, round or sector shaped conductors
- Wide application ranges
- Connector bodies made of a high-tensile, tin-plated aluminium alloy
- Grooved internal surface of the conductor hole
- Lubricated shear bolts with predetermined shear torque made of special aluminium
- The BSM connectors included in connection kits (excluding SMOE-82283) exceed requirements according to IEC 61238-1 class A. The connector type BSLB (kit SMOE-82283) exceeds requirements according to DIN VDE 0220 Part1.
- Heat-shrinkable tubing, supplied with kit, ensures perfect sealing and electrical insulation

For cable terminations see Insulation Accessories at page 25 and 26, which include heat-shrinkable breakouts, sealing and protection tubing.



Type: SMOE-xxxx



Type: BSM



Type: BSLB

Connection kits with connectors type BSM

| Ordering description | Cross section (mm ²) | Length of sealing tubing (mm) | Hexagon contact bolts | |
|----------------------|----------------------------------|-------------------------------|-----------------------|-------------------------|
| | | | Quantity (pc) | Width across flats (mm) |
| SMOE-82281 | 10 – 35 | 125 | 2 | 10 |
| SMOE-82282 | 25 – 95 | 150 | 2 | 13 |
| SMOE-82284 | 35 – 150 | 200 | 2 | 17 |
| SMOE-82285 | 95 – 240 | 280 | 4 | 19 |

NOTE All connection kits contain 4 connectors and 4 heat-shrinkable, sealing tubing.

Connection kit with sector shaped conductor channel connector type BSLB

| Ordering description | Cross section (mm ²) | Length of sealing tubing (mm) | Allen contact bolts | |
|----------------------|----------------------------------|-------------------------------|---------------------|-------------------------|
| | | | Quantity (pc) | Width across flats (mm) |
| SMOE-82283 | 25 – 150 | 200 | 2 | 8 |

NOTE The connection kit contains 4 connectors and 4 heat-shrinkable, sealing tubing.

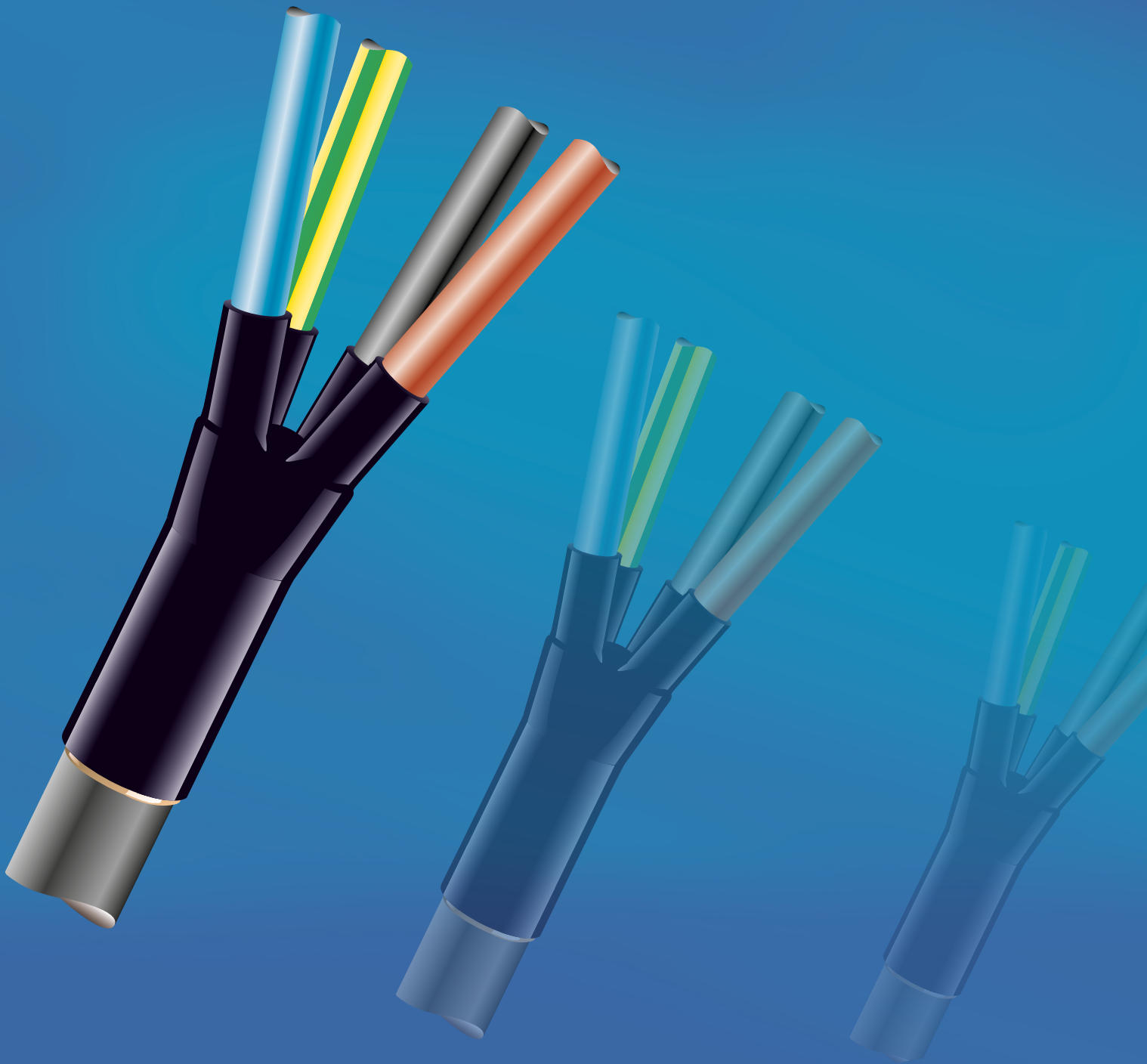



Chapter III Connection and insulation accessories

| | |
|--|----|
| Heat-shrinkable sealing breakouts with 2 to 5 fingers | 26 |
| Heat-shrinkable sealing, marking and protection tubing | 27 |
| Sealing end caps | 28 |
| Repair sleeves and tapes | 29 |
| Fuse cutout for services line..... | 31 |
| Short-circuiting and earthing adapter and equipment | 32 |

Heat-shrinkable sealing breakouts with 2 to 5 fingers

Application

For crutches' sealing of multi-core cables, LV-ABC cables and cable entries into ducts. To seal onto all common plastics and metals, all outlets are coated with hot-melt adhesive. The breakouts are resistant to UV-light and weathering. Breakouts are available for 2, 3, 4 and 5 core cables, in a variety of sizes. For dimensional details see table below.

Dimensions

H: Diameter of large outlet
J: Diameter of small outlets
P: Length of breakout
a: as delivered
b: after free recovery



Type: 502Kxxx/S

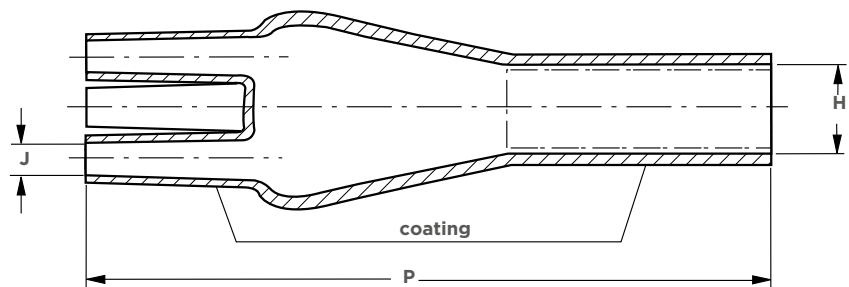

| Ordering description | Number of cable cores | Recommended cross section (mm ²) | Dimensions (mm) | | | | | |
|----------------------|-----------------------|--|-----------------|----------|----------|----------|----------|-----|
| | | | H | | J | | P | |
| | | | a (min.) | b (max.) | a (min.) | b (max.) | b (±10%) | |
| 28 | 2 | 4 – 35 | 28 | 9.2 | 15 | 4.1 | 90 | |
| 302K224/S | | 50 – 150 | 48 | 32 | 22 | 7 | 172 | |
| 302K466/S | | 150 – 400 | 86 | 42 | 40 | 17 | 200 | |
| 402W533/S | 3 | 4 – 35 | 38 | 13 | 16 | 4.2 | 103 | |
| 402W516/S | | 50 – 150 | 63 | 22 | 26 | 9 | 180 | |
| 402W526/S | | 95 – 500 | 95 | 28 | 44 | 13 | 205 | |
| 502S013/S | 4 | 1.5 – 10 | 23 | 9.5 | 7 | 2 | 60 | |
| 502K033/S | | 4 – 50 | 45 | 16.5 | 14 | 3.4 | 97 | |
| 502K046/S | | 25 – 95 | 45 | 19 | 20 | 7 | 165 | |
| 75 | | 50 – 150 | 25 | 25 | 9 | 217 | 217 | |
| 502K026/S | | 120 – 400 | 100 | 31 | 40 | 13.5 | 223 | |
| 603W035/S | | 4 + 1* | 25** – 120 | 68 | 26 | 30* | 7* | 182 |

* One of 5 outlets dim = 20/6 (mm).

** For smaller cross sections use 502K033/S with 2 cores inside an outlet.

Installation steps with typical components for transition terminations of cables to LV-ABC lines.

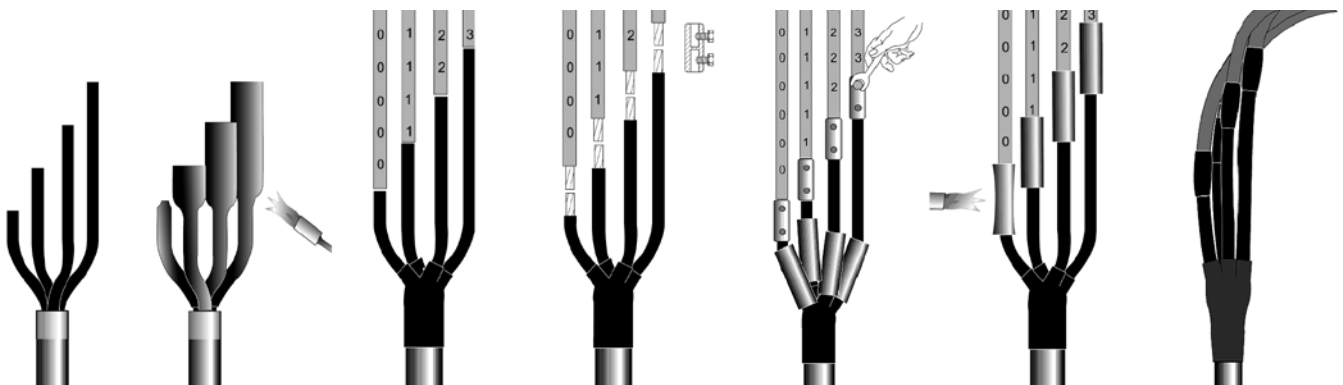

Heat-shrinkable sealing, marking and protection tubing

Application of EN-CGPT

Thin-wall, flexible heat-shrinkable EN-CGPT tubing is uncoated and resistant to UV light and weathering. It is recommended to install it over a core insulation of terminating cables in case that is not resistant to UV light.

Application of EN-DCPT

As marking and protection tubing for grounding wires, cables and busbars the dual colour (yellow/green) EN-DCPT, thin wall tubing is recommended. The tubing is weathering and UV resistant.

Application of MWTM

Medium-wall, heat shrinkable MWTM tubing is recommended for general electrical insulation and sealing over connectors and lugs and onto the cable insulation. The tubing is resistant to UV light and weathering and coated with hot melt adhesive, which seals to all common plastics and metals.



Type: EN-CGPT



Type: EN-DCPT



Type: MWTM

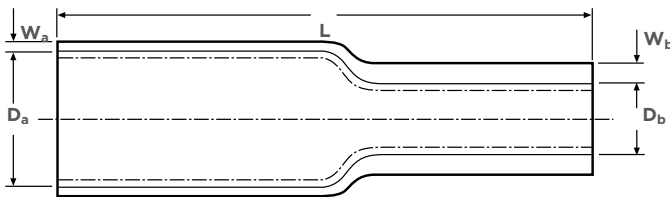

Dimensions

- D:** Diameter
- W:** Wall-thickness
- L:** Length
- a:** as delivered
- b:** after free recovery

| Ordering description | Recommended cross section (mm ²) | | Application diameter (mm) | | Dimensions (mm) | | | | |
|---|--|------|---------------------------|------|-----------------|---------------------------|----|---------------------------|------|
| | min. | max. | min. | max. | L (nom.) | D a (min.) b (max.) | | W a (min.) b (max.) | |
| EN-CGPT – thin wall, black, insulation and protection tubing | | | | | | | | | |
| EN-CGPT-9/3-0-SP | 1.5 | 10 | 3.3 | 8.0 | on spool | 9 | 9 | – | 0.75 |
| EN-CGPT-12/4-0-SP | 4 | 35 | 4.5 | 10.5 | on spool | 12 | 4 | – | 0.75 |
| EN-CGPT-18/6-0-SP | 16 | 95 | 7.0 | 16.0 | on spool | 18 | 6 | – | 0.85 |
| EN-CGPT-24/8-0-SP | 35 | 150 | 9.0 | 21.5 | on spool | 24 | 8 | – | 1.00 |
| EN-CGPT-39/13-0-SP | 120 | 400 | 14.5 | 35.0 | on spool | 39 | 13 | – | 1.15 |
| EN-DCPT – thin wall, green/yellow, marking and protection tubing for grounding wires, cables and busbars | | | | | | | | | |
| EN-DCPT-6/3-45-SP | 1.5 | 10 | 3.2 | 5.6 | on spool | 6 | 3 | – | 0.58 |
| EN-DCPT-8/4-45-SP | 4 | 16 | 4.5 | 7.6 | on spool | 8 | 4 | – | 0.64 |
| EN-DCPT-10/5-45-SP | 10 | 25 | 5.5 | 9.5 | on spool | 10 | 5 | – | 0.64 |
| EN-DCPT-12/6-45-SP | 16 | 35 | 6.5 | 11.5 | on spool | 12 | 6 | – | 0.64 |
| EN-DCPT-19/9-45-SP | 50 | 120 | 10.0 | 18.0 | on spool | 19 | 9 | – | 0.76 |
| EN-DCPT-26/13-45-SP | 120 | 185 | 14.0 | 25.0 | on spool | 26 | 13 | – | 0.89 |
| EN-DCPT-38/19-45-SP | 185 | 400 | 23.0 | 35.0 | on spool | 38 | 19 | – | 1.00 |
| MWTM – medium wall, black, insulation and sealing tubing | | | | | | | | | |
| MWTM-10/3-1000/S | 1.5 | 10 | 3.5 | 9.0 | 1000 | 10 | 3 | 0.3 | 1.0 |
| MWTM-16/5-1000/S | 4 | 35 | 5.5 | 14.5 | 1000 | 16 | 5 | 0.3 | 1.4 |
| MWTM-25/8-1000/S | 25 | 70 | 9.0 | 22.5 | 1000 | 25 | 8 | 0.4 | 2.0 |
| MWTM-35/12-1000/S | 70 | 150 | 13.0 | 31.5 | 1000 | 35 | 12 | 0.4 | 2.0 |
| MWTM-50/16-1000/S | 150 | 400 | 17.5 | 45.0 | 1000 | 50 | 16 | 0.5 | 2.0 |

NOTE EN-CGPT and EN-DCPT tubing are delivered on spools and can be cut to desire length at site. Other heat-shrinkable tubing, either with or without adhesive coating, is available on request.

Sealing end caps

Application

The elastomeric end caps are pre-moulded and simply pushed over the conductors. These end caps are made of thermoplastic, UV-resistant material and fulfil voltage tests of 6 kV under water according to NFC 33020 and EN 50483-4.



Type: CECT

Application of 102L

On the inside coated with hot-melt adhesive, the heat-shrinkable end caps are used to seal and protect the ends of insulated LV-ABC and cable conductors. Larger sizes are available to seal plastic, paper and rubber insulated cables during storage, transport and cable laying. The end caps are resistant to UV-light and weathering.



Type: 102L

Dimensions

D: Diameter

W: Wall-thickness

L: Length

a: as delivered

b: after free recovery

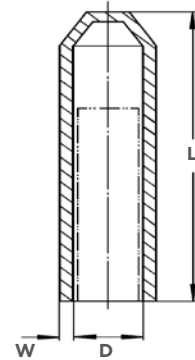

Elastomeric end caps - CECT

| Recommended Cross section (mm ²) | Application diameter (mm) | Ordering description |
|--|---------------------------|----------------------|
| 6 – 35 | 4.5 – 11.5 | CECT 6 – 35 |
| 16 – 150 | 6.5 – 19.0 | CECT 16 – 150 |

Heat-shrinkable end caps - 102L

| Ordering description | Recommended cross section (mm ²) | Application diameter (mm) | | Dimensions (mm) | | | |
|----------------------|--|---------------------------|---------------|-----------------|----------|-----------|-----------|
| | | | | D | | L | W |
| | | | | a (min.) | b (max.) | b (±10 %) | b (±20 %) |
| 10 | 4 – 25 | 4 – 8 | 102L011-R05/S | 4 | 38 | 2.0 | – |
| 20 | 16 – 120 | 8 – 17 | 102L022-R05/S | 7.5 | 55 | 2.8 | – |
| 35 | 120 – 300 | 17 – 30 | 102L033-R05/S | 15 | 90 | 3.2 | – |
| 55 | – | 30 – 45 | 102L044-R05/S | 25 | 143 | 3.9 | – |
| 75 | – | 45 – 65 | 102L048-R05/S | 32 | 150 | 3.3 | – |
| 100 | – | 65 – 95 | 102L055-R05/S | 45 | 162 | 3.8 | – |
| 120 | – | 95 – 115 | 102L066-R05/S | 70 | 145 | 3.8 | – |
| 70 | – | 95 – 115 | 102L066-R05/S | 70 | 145 | 3.8 | – |

Heat-shrinkable repair sleeve

Application

The general purpose of CRSM wraparound is to be used for a fast and reliable repair of polymeric insulated conductors and cable sheaths to re-established the electrical and mechanical integrity of the cable. The wraparound is supplied with an adhesive coating and is resistant to UV-light and weathering.

Dimensions

- D:** Diameter
- W:** Wall-thickness
- L:** Length

- a:** as delivered
- b:** after free recovery

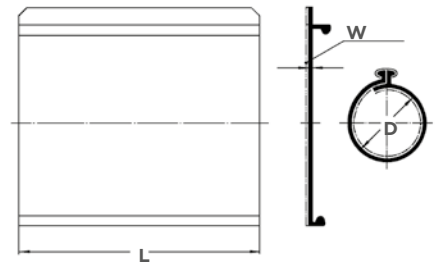

Type: CRSM

| Ordering description | Recommended cross section (mm ²) | Application diameter (mm) | Dimensions (mm) | | | | |
|----------------------|--|---------------------------|-----------------|----------|----------|----------|------------|
| | | | D | | W | | L |
| | | | a (min.) | b (max.) | a (min.) | b (min.) | a (±15 mm) |
| CRSM 34/10- 250/239 | 35 – 150 | 11 – 21 | 35 | 9 | 0.3 | 2.4 | 250 |
| CRSM 34/10- 500/239 | | | | | | | 500 |
| CRSM 34/10-1000/239 | | | | | | | 1000 |
| CRSM 34/10-1500/239 | | | | | | | 1500 |
| CRSM 53/13- 250/239 | 70 – 400 | 17 – 32 | 54 | 15 | 0.3 | 2.0 | 250 |
| CRSM 53/13- 500/239 | | | | | | | 500 |
| CRSM 53/13- 750/239 | | | | | | | 750 |
| CRSM 53/13-1000/239 | | | | | | | 1000 |
| CRSM 53/13-1500/239 | | | | | | | 1500 |

GelWrap - Gel-filled Wrap-Around Splice Cover and Repair Sleeve

Application

The GelWrap sleeve quickly and conveniently insulates and seals the connection area or the area of overhead repair. It is simple wraparound design with dependable gel sealing performance. The sleeve is wrapped and snapped.

Features

- Fast and easy installation, even when wearing insulated gloves
- Silicone gel (PowerGel) is high dielectric strength insulation and excellent water sealant over wide operation temperature ranges (-40°C to 95°C)
- Elastomer cover material combines outstanding tear strength, abrasion and chemical resistant
- Innovative snap-lock design with excellent flexibility and range-taking
- Resistant to UV-light and weathering

Dimensions

- D:** Diameter
- L:** Length



Type: GelWrap

| Ordering description | Diameter (mm) | Length |
|----------------------|---------------|--------|
| GelWrap-18/4-150 | 4-18 | 150 |
| GelWrap-18/4-200 | 4-18 | 200 |
| GelWrap-18/4-250 | 4-18 | 250 |
| GelWrap-33/10-150 | 10-33 | 150 |
| GelWrap-33/10-200 | 10-33 | 200 |
| GelWrap-33/10-250 | 10-33 | 250 |
| GelWrap-50/20-250 | 20-50 | 250 |
| GelWrap-50/20-300 | 20-50 | 300 |



Center GelWrap sleeve over connector or area of overhead repair.



Wrap sleeve around connector or repair area and shut snap locks over entire length of sleeve.



Install cable ties at outermost notches of snap lock.

Fuse cutout for service lines

Application

These removable circuit breakers are installed on service lines as fuse with 4 to 125A and allow disconnection under load up to 60A. Attached sealing cap allows to temporary protect access to the network side.
The connection to the service line of 6, 10, 16, or 25mm is performed by crimping, see page 9 for crimping details.

Features

- Suitable for 22x58 AD fuse cartridges from 4 to 155A
- Allows connection and disconnection under load up to 60A
- Passes 6 kV test under water (NFC 33020, EN 50483-4 class 1)
- Two part body with integrated seals easily interlock during closing
- Die size E140 for both sizes (tools and dies see page 37)
- Insulation material made of weather and UV resistant polymer

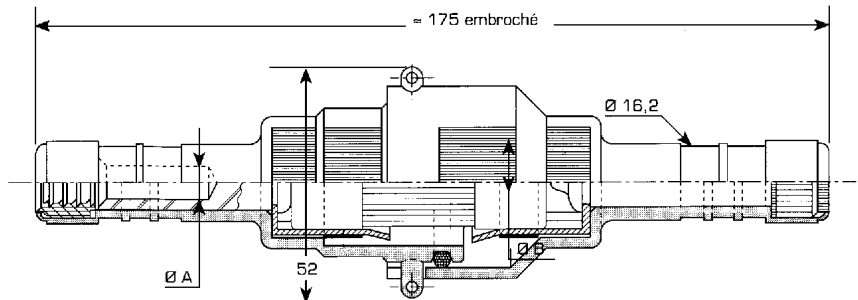

Connection and insulation accessories

Fuse cutouts

| Ordering Description | Cross Section (mm ²) | Fuse Dimensions and Size | | Weight (kg/100 pcs) |
|----------------------|----------------------------------|--------------------------|---------|---------------------|
| | | (mm) | (A) | |
| CCFBD | 6 | 6-6 | 22 x 58 | 13.0 |
| CCFBD | 10 | 10-10 | 22 x 58 | 13.0 |
| CCFBD | 16 | 16-16 | 22 x 58 | 12.5 |
| CCFBD | 25 | 25-25 | 22 x 58 | 12.5 |

Fuse cutouts

| Ordering Description | Size (mm x mm) | Rated in Current | Rated Voltage | Interrupting rating (A) | Weight (kg/100 pcs) |
|----------------------|----------------|------------------|---------------|-------------------------|---------------------|
| | | (A) | (V) | | |
| AD 16-22x58 | 22 x 58 | 16 | 500 | 80 000 | 12.5 |
| AD 30-22x58 | 22 x 58 | 32 | 500 | 80 000 | 12.5 |
| AD 60-22x58 | 22 x 58 | 63 | 500 | 80 000 | 12.5 |
| CCFBD | 25 | 25-25 | 22 x 58 | 22 x 58 | 12.5 |

NOTE Fuses according to IEC 269-2 and NFC 63 210, other sizes available on request

Insulated short-circuiting and earthing adapter for piercing connectors

Application

The PMCC adapter is installed on the tap-off side of an insulation piercing connector (type P2X, see page 9), usually close to the end of a line or at intersections. The insulating cover is removed for access to the inside brass stud fitted with a bayonet lock. A hole drilled into the stud provides a reliable point of contact for voltage testing.

The connection to earth is done by insulated earthing equipment.

Features

- Suitable for all piercing connectors designed for tap conductors of 25 mm² (insulated conductor diameter of 9 mm)
- Designed for short circuit currents up to 4 kA/1s, permanent currents up to 200 A
- Phases are easily identified by phase neutral indexes (breakable flags)
- Passes 6 kV test under water (NFC 33020, EN 50483-4 class 1)



Type: PMCC



Type: PMCC + P2X 95 Mk2

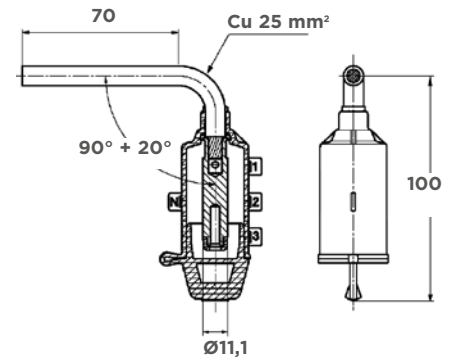

| Ordering Description | Insulated conductor | Diameter | I _{max} | Stud dimension | | Weight (kg/100 pcs) |
|----------------------|----------------------------------|----------|------------------|----------------|-------------|---------------------|
| | Cross section (mm ²) | (mm) | (kA/1s) | Diameter (mm) | Length (mm) | |
| PMCC | 25 | 9.0 | 4 | 11.1 | 35 | 8.4 |

Short-circuiting and earthing equipment

Application

After checking for absence of voltage, the earthing and short circuiting equipment is connected to ground and then the studs inserted in PMCC adapters, thus following the common safety rules.

Features

Short-circuiting equipment

consisting of 6 or 7 stud pins with bayonet lock connected by highly flexible insulated copper cable, delivered in transport box. Conforms to EN 61230 and IEC 1230.

Designed for short circuit currents up to 4 kA/1s, permanent currents up to 200 A. Contact stud dimensions Ø 11,1 mm, length 35 mm (according to NFC 33020-HT33 S69).

Earthing equipment

consisting of an insulated splicing bayonet to connect on a stud pin, highly flexible insulated copper cable and an earth clamp for connection to an earth rod, delivered in a transport box. Designed for short circuit currents up to 4 kA/1s.

Earthing rods are made of stainless steel with diameter of 16 mm and length of 1 m.

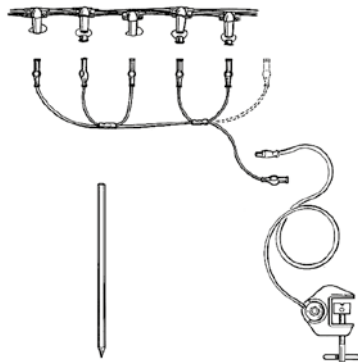

Connection and insulation accessories

| Ordering Description | Type | Diameter | I _{max} | Box Dimension | Weight (kg/100 pcs) |
|-----------------------------------|------------------|----------------|------------------|-----------------|---------------------|
| | | (mm) | (kA/1s) | (mm) | |
| Short circuiting equipment | | | | | |
| MT-206 | 6 stud pins | 16 | 4 | 234 x 215 x 75 | 1.6 |
| MT-207 | 7 stud pins | 16 | 4 | 234 x 215 x 75 | 1.9 |
| Earthing equipment | | | | | |
| MT-245 | 10 m cable | 16 | 4 | 310 x 280 x 105 | 3.2 |
| PT-INOX-160/AA-1M | 1 m earthing rod | (Dia. 16.0 mm) | - | - | 1.5 |

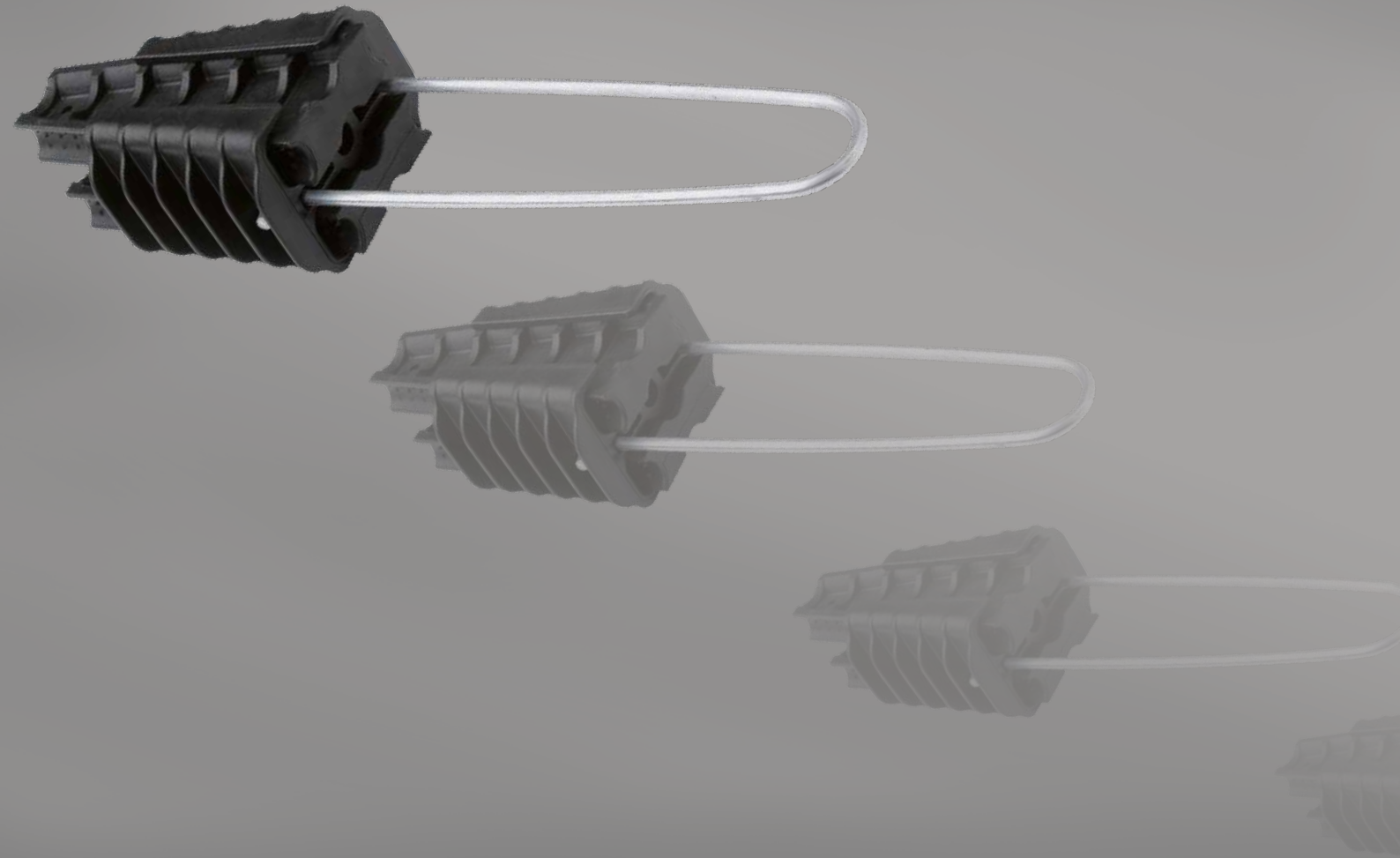

Chapter IV

Anchoring and suspension

Anchor and suspension clamps for

| | |
|--|----|
| Service cables..... | 36 |
| Self supporting LV-ABC lines | 38 |
| LV-ABC lines with insulated neutral messenger..... | 40 |

Anchor and suspension accessories

| | |
|---|----|
| Wall mounted saddles and cable ties | 42 |
| Steel straps and protection devices | 43 |
| Hooks, brackets and bolts | 44 |

Anchor and suspension clamps for service cables

Application of PA 25x100

The clamp is designed to anchor insulated service lines with 2 or 4 conductors. The clamp is composed of a body, 2 wedges and removable and adjustable bail.

Features

- Tool free installation with wedges sliding inside the body
- Easy to open bail permits fixing to brackets and pigtails
- Adjustable length of bail in three steps, max. length of clamp 208 mm
- Exceeds requirements according to NF C 33 042
- Clamp made of weather and UV resistant polymer
- Adjustable link made of hot dip galvanized steel



Type: PA 25x100

Application of PA 9-17 and PAS

The clamps are equipped with an adapted wedge for anchoring of round insulated service lines with up to 4 conductors.

Features

- different from clamp PA 25x100
- Adjustable length of bail in four steps, max. length of clamp 220 mm



Type: PA 9-17

Application of RA 25

The clamp is designed for suspension applications of insulated service lines with 2 or 4 conductors.

Features

- For angles of the line up to 90°
- Tool free installation with core separator
- Easy to open bail permits fixing to brackets and pigtails
- Exceeds requirements according to NF C 33 042
- Clamp is made of weather and UV resistant polymer



Type: RA 25

Anchor clamp for insulated overhead conductors (self-supporting)

| Ordering description | Cross section (mm ²) | | Breaking load (kN) | Weight (kg/10 pcs) |
|----------------------|----------------------------------|--------|--------------------|--------------------|
| | min. | max. | | |
| PA 25x100 | 2 x 16 | 4 x 25 | 2.0 | 1.0 |

Anchor clamps with rigid bail for round cables

| Ordering description | Diameter (mm) | | Breaking load (kN) | Weight (kg/10 pcs) |
|----------------------|---------------|------|--------------------|--------------------|
| | min. | max. | | |
| PA 9-17/GALVA | 9 | 17 | 2.0 | 1.4 |
| PAS 35 | 18 | 25 | 2.0 | 1.3 |

Suspension clamp for insulated overhead conductors and cables

| Ordering description | Cross section (mm ²) | | Breaking load (kN) | Weight (kg/10 pcs) |
|----------------------|----------------------------------|--------|--------------------|--------------------|
| | min. | max. | | |
| RA 25 | 2 x 16 | 4 x 25 | 2.0 | 0.9 |

NOTE For brackets and hooks see pages 44 and 45.

Anchor and suspension clamps for service cables

Application

The clamps are designed to anchor or suspend insulated service lines with 2 or 4 conductors.

Features

- Clamp can be used as suspension clamp by simply rotating blocks
- Strap available either with closed eye (32.5 x 22.5 mm) or open eye (opening 18 mm)
- Simple single bolt installation with 17 mm spanner
- Clamp with short length of 165 mm
- Exceeds slipping requirements of 4 kN according to EATS 43-14
- Exceeds requirements according to VDE 0211
- Clamp made of weather and UV resistant glass fibre reinforced polymer and hot dip galvanized steel



Type: HEL-5505



Type: HEL-5505-B

Anchor and suspension clamps for insulated overhead conductors (self-supporting)

| Ordering description | Cross section (mm ²) | | Support strap type | | Breaking load (kN) | Weight (kg/10 pcs) |
|----------------------|----------------------------------|--------|--------------------|----------|--------------------|--------------------|
| | min. | max. | closed eye | open eye | | |
| HEL-5505-2 | 2 x 16 | 2 x 35 | X | | 12 | 4.3 |
| HEL-5505-2B | 2 x 16 | 2 x 35 | | X | 5 | 4.3 |
| HEL-5505 | 2 x 16 | 4 x 35 | X | | 12 | 5.2 |
| HEL-5505-B | 2 x 16 | 4 x 35 | | X | 5 | 5.2 |

NOTE For brackets and hooks see pages 44 and 45.

Anchor clamps for self supporting LV-ABC lines

Application of PA 25x100

The clamps are designed to anchor self supporting LV-ABC lines with 2 to 4 cores. The wedge type clamp is self-adjusting. Pilot wires or street lighting conductors are led alongside the clamp.

The insertion of conductors is facilitated by an integrated spring, which helps open the clamp. The version with movable arms in addition simplifies the installation.

Features

- Single M12 bolt and self-locking nut allow clamp to be fixed also to closed eye screws and brackets
- Short length of approx. 320 mm
- Exceeds requirements according to EATS 43-14 and VDE 0211 and EN 50483-2
- Clamp made of weather and UV-light resistant glass fibre reinforced polymer and hot dip galvanized steel



Type: HEL-55xx with fixed arm



Type: HEL-55xx with movable arm

| Cross section (mm ²) | Ordering description | Breaking load (kN) | Weight (kg/10 pcs) |
|----------------------------------|----------------------|--------------------|--------------------|
| With fixed arm | | | |
| 4 x 10 – 35 | HEL-5505* | 12.0 | 5.2 |
| 4 x 25 – 50 | HEL-5506 | 28.0 | 10.0 - 12.0 |
| 4 x 70 – 95 | HEL-5507 | 43.0 | 13.0 |
| 4 x 120 | PA 4 120 | 60.0 | 20.0 |
| With movable arm | | | |
| 4 x 25 – 50 | HEL-5503 | 28.0 | 10.0 - 13.0 |
| 4 x 70 – 95 | HEL-5504 | 43.0 | 11.0 - 14.0 |

NOTE

For detailed information about HEL-5505, please see page 37.
For brackets and hooks see pages 44 and 45.

Suspension clamps for self supporting LV-ABC lines

Application

The clamps are designed to suspend self supporting LV-ABC lines. They can be also used for LV-ABC lines with bare and insulated neutral messenger.

Features

Suspension clamp PS

- Can be installed in straight direction and in line deviation angle up to 30°
- Tool free installation, equipped with wing nut
- Exceeds requirements according to ESI 43-14 and VDE 0211
- Made of weather and UV-light resistant elastomer and hot dip galvanized steel
- Fits to hooks and pigtails up to a diameter of 21 mm
- Operating load 2.5 kN

Universal suspension clamp USC

- Range taking: 4 x 25-120 mm²
- Can be installed in straight direction and in line deviation angle up to 40° for 4 x 25 - 50 mm² and up to 20° for 4 x 70 - 120 mm²
- Qualified according to EN 50483-2
- Reopen clamp allows easy positioning of the cables
- Fits to all common hooks and pigtails
- Not lose parts
- Made of weather and UV-light resistant thermoplastic and steel with Geomet (Chromium free) protection
- Versions with shear head and wing nuts are available on request

Rolling suspension clamp RSC

- Deviation angle up to 90°
- Assembly rolls can be used to run out a conductor during line mounting
- Not lose parts
- Made of weather and UV-light resistant elastomer and hot dip galvanized steel
- Equipped with a stainless steel reinforced ring in the hook attachment
- Easy to install with a spanner
- Fits to hooks and pigtails up to a diameter of 20 mm



Type: PS-xxx



Type: USC 25-120



Type: RSC 25-120

| Cross section (mm ²) | Bundle diameter (mm) | Ordering Description | Breaking load (kN) | Weight (kg/10 pcs) |
|-----------------------------------|----------------------|----------------------|--------------------|--------------------|
| Suspension clamps | | | | |
| 2 x 50 – 4 x 35 | 21 – 25 | PS 250/435 | 7.5 | 4.1 |
| 2 x 95 – 4 x 50 | 26 – 30 | PS 450 | 7.5 | 3.8 |
| 4 x 70 | 31 – 35 | PS 470 | 7.5 | 3.6 |
| 4 x 95 | 36 – 40 | PS 495 | 7.5 | 3.5 |
| 4 x 120 | 40 – 43 | PS 4120 | 7.5 | 4.4 |
| Universal suspension clamp | | | | |
| 4 x 25 – 120 + 2 x 25 | up to 42 | USC 25-120 | 18.0 | 5.0 |
| Rolling suspension clamp | | | | |
| 4 x 25 – 120 + 2 x 25 | 22 – 42 | RSC 25-120 | 2.4* | 11.0 |

* Slippage load

NOTE For brackets and hooks see pages 44 and 45.

Anchor clamps for LV-ABC lines with insulated neutral messenger

Application

The clamps are designed to anchor LV-ABC lines with insulated neutral messenger. The clamp consists of an aluminium alloy cast body and self-adjusting plastic wedges which clamp the neutral messenger without damaging its insulation.

The flexible stainless steel bail protected by plastic wear-resistant saddle allows installations of up to 3 clamps on a bracket. The clamp and the bracket are available either separately or together as assembly.

Features

- Tool free installation
- Not lose parts
- Exceeds requirements according to EN 50483-3 and NFC 33 041
- Clamp body made of corrosion resistant aluminium alloy, bail of stainless steel, wedges of weather and UV resistant polymer
- Universal fixing of bracket by 2 bolts M14 or stainless steel straps of 20 x 0.7 mm.
- Bracket made of corrosion resistant aluminium alloy
- Maximum line deviation angles of 50° for single and 100° for double anchoring:

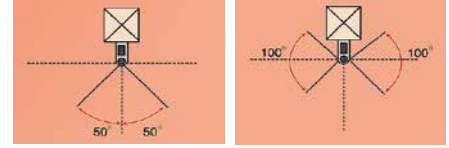

Type: PA 1500x20

Type: EA xxxx

Dimensions: mm

| Neutral messenger Cross section (mm ²) | Diameter (mm) | Ordering Description | Breaking load (kN) | Weight (kg/10 pcs) |
|--|---------------|----------------------|--------------------|--------------------|
| Anchor clamp without bracket | | | | |
| 25 – 35 | 8 – 11 | PA 1000 | 10.0 | 3.2 |
| 50 – 70 | 12 – 14 | PA 1500x20 | 15.0 | 3.4 |
| 50 – 70 | 12 – 14 | PA 2000 | 20.0 | 4.1 |
| 95 | 14 – 16 | PA 95-2000 | 20.0 | 4.1 |
| Universal suspension clamp | | | | |
| 25 – 35 | 8 – 11 | EA 1000 | 10.0 | 5.7 |
| 50 – 70 | 12 – 14 | EA 1500 | 15.0 | 5.9 |
| 50 – 70 | 12 – 14 | EA 2000 | 20.0 | 6.4 |
| 95 | 14 – 16 | EA 95-2000 | 20.0 | 6.4 |
| Rolling suspension clamp | | | | |
| – | – | CA 1500-2 | 15.0 | 2.0 |
| – | – | CA 1500/2000 | 20.0 | 2.3 |

NOTE For brackets and hooks see pages 44 and 45.

Suspension clamps for LV-ABC lines with insulated neutral messenger

Application

The clamps are designed to suspend LV-ABC lines with insulated neutral messengers. The neutral messenger is fixed by an adjustable grip device. A movable link allows longitudinal and transversal movement of the clamp body.

Standard clamp version ES is supplied with preinstalled bracket. The upper bulge of the bracket prevents the clamp from turning over the pole.

The clamps are also available without bracket (version PS) and with a fuse link (ESF). PS clamps are fixed to a pole by a pig tail hook or bracket.

Features

- Tool free installation
- Not lose parts
- Clamp and link made of polymer giving an additional insulation between the cable and the pole.
- Exceeds requirements according to EN 50483-3 and NFC 33 040
- Clamp and movable link made of weather and UV-light resistant glass fiber reinforced polymer
- Universal fixing of bracket by 1 bolt M16 or 2 stainless steel straps of 20 x 0.7 mm
- Bracket made of corrosion resistant aluminium alloy
- Maximum line deviation angles of 30° towards the pole and up to 50° pulling away from the pole:

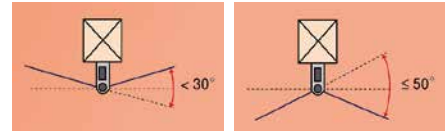

(For larger line deviation angles 2 anchor clamps shall be used)



Type: ES 1500 25-95



Type: PS 1500+LM25-95

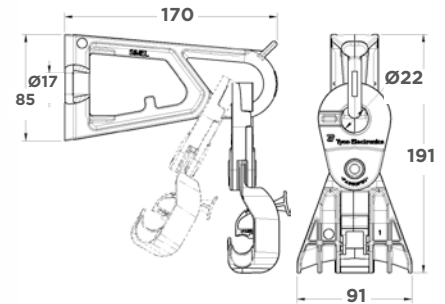

Dimensions: mm

| Cross section (mm ²) | Bundle diameter (mm) | Ordering Description | Breaking load (kN) | Hole diameter max. (mm) | Weight (kg/10 pcs) |
|--|----------------------|----------------------|--------------------|-------------------------|--------------------|
| Clamp without bracket and mobile link | | | | | |
| 16 – 35 | 8 – 11 | PS 35 | 4.3 | 25.0 | 0.8 |
| 95 – 120 | 15 – 17.5 | PS 120 | 30.0 | 25.0 | 2.5 |
| Universal suspension clamp | | | | | |
| 25 – 95 | 8.3 – 16.3 | PS 1500+LMx25-95 | 12.0 | 22.0 | 1.6 |
| Clamp with pre-installed bracket | | | | | |
| 16 – 35 | 8 – 11 | ES 35-1500 | 4.3 | – | 2.8 |
| 25 – 95 | 8.3 – 16.3 | ES 1500 25-95 | 12.0 | – | 3.5 |
| 25 – 95 | 8.5 – 16.3 | ES 95-2000 | 16.0 | – | 4.2 |
| 25 – 95 | 8.3 – 16.3 | PS 1500+LMx25-95 | 12.0 | 22.0 | 1.6 |
| Clamp with bracket and fuse link | | | | | |
| 50 – 70 | 10 – 13.5 | ESF 54/70 | 7.0 | – | 3.2 |

NOTE For other cable dimensions see also suspension clamps for self supporting LV-ABC lines at page 38. For brackets and hooks see pages 44 and 45.

Wall mounted saddles and cable ties for LV-ABC lines

Application

The wall mounted saddles are designed to install LV-ABC lines (self-supporting or insulated neutral messenger type) alongside walls and poles.

The LV-ABC cable is fixed to the saddle by a cable tie. A second cable can be installed on the same support by hanging it down from the bottom side with an additional cable tie (to be ordered separately).

Features

- The body of saddles and the cable ties are made of weather and UV-light resistant polymer material
- BRPF products withstand the tests described in the NFC 33 040
- Width of cable ties 9 mm
- Black colour
- Halogen free and flame retarded
- Temperature ranges:
operating -50 °C to +80 °C
installation -15 °C to +60 °C
max. allowed peak 120 °C

Installation

The expansion plastic pin is inserted in a drilled hole of \varnothing 12 mm and fixed to a wall by hammering a nail inside up to the contact with the pin. The plastic cap is placed over the nail's head for its protection. The cable tie fixes a variety of cables to the saddle. Usually, every 0.6 m a saddle is installed on a wall. For applications on walls or poles with soft material like wood, the expansion plug is simply cut off and the nail directly hammered into the wood.

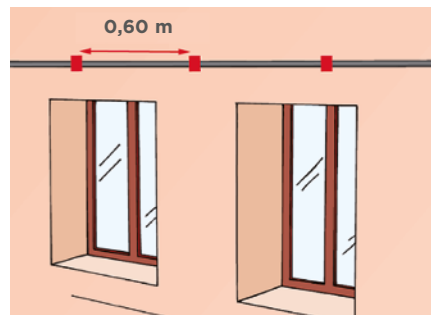

Application

The CSBF-C is holding assembly mainly used to clamp a cable to walls. It consists of a cable tie CSB and a hammer-in support for drilled holes in walls (\varnothing 8 mm).



Type: BRPF

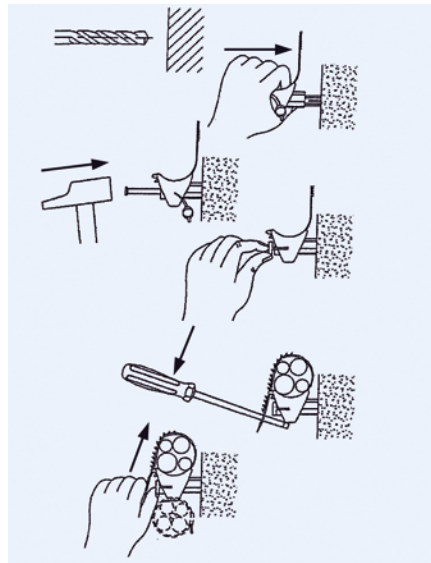

Type: BRPF

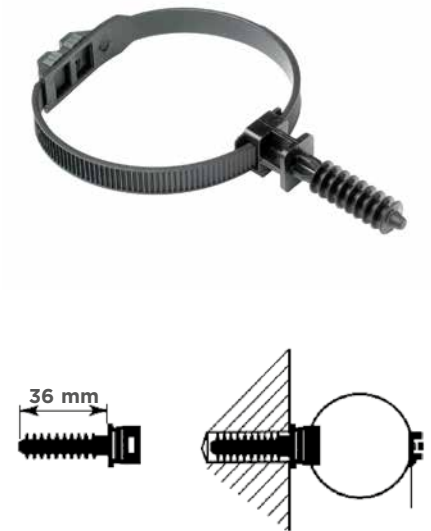

Type: CSBF-C

| Cable diameter (mm) | Ordering Description | Spacing to wall D (mm) | Lenght (mm) | Breaking load (kN) | Weight (kg/100 pcs) |
|--|----------------------|------------------------|-------------|--------------------|---------------------|
| Wall mounted saddles | | | | | |
| 20 – 60 | BRPF 1 | 10 | – | 2.0 | 4.8 |
| 20 – 60 | BRPF 6 | 60 | – | 2.0 | 8.2 |
| Holding assembly with cable tie | | | | | |
| 0 – 40 | CSBF-C | – | 180 | – | 0.5 |
| Cable ties | | | | | |
| 8 – 27 | CS 922 | – | 132 | 0.35 | 1.8 |
| 10 – 45 | CSB | – | 180 | 0.35 | 2.6 |
| 26 – 66 | CSL 260 | – | 265 | 0.51 | 3.6 |
| 55 – 93 | CSL 350 | – | 360 | 0.51 | 5.0 |

NOTE Tools for steel straps see page 49.

Steel straps and protection devices for LV-ABC lines

Application

Stainless steel straps are used to attach cable protection, anchoring and suspension assemblies and other devices mainly to poles.

The steel straps are cut from a roll to the required length. The strap is fixed with the appropriate buckle and a binding tool.

Features

- stainless steel grade 202
- min. breaking strength 0.6 kN/mm²
- width of 10 and 20 mm
- thickness of 0.4 and 0.7 mm
- rolls of 50 m in carrier case

Application

Extruded PVC profiles GPT and GPC are used to protect cables and conductors against damages alongside poles or walls.

Features

- type GPT 30 x 30 mm to be fixed by straps
- type GPC to be fixed either by screws Ø 6 mm (hole Ø 7 mm) or straps (slit approx. 3 x 30 mm)
- available in 3 colours



Type: RF 1007, A 100



Type: GPT



Type: GPC

| Ordering Description | Application | Dimensions (mm) | Packaging unit | Weight (kg/unit) |
|---------------------------------------|---------------------------|-----------------|----------------------|------------------|
| Stainless steel straps | | | | |
| RF 1004 50M | | 10 x 0.4 | 1 roll of 50 m | 1.8 |
| RF 1007 50M | | 10 x 0.7 | 1 roll of 50 m | 3.0 |
| RF 2004 50M | | 20 x 0.4 | 1 roll of 50 m | 3.4 |
| RF 2007 50M | | 20 x 0.7 | 1 roll of 50 m | 5.7 |
| Buckles for straps | | | | |
| A 100 | for RF 1000 series | 11 | 1 bag of 100 buckles | 0.5 |
| A 200 | for RF 2000 series | 21 | 1 bag of 100 buckles | 1.1 |
| Extruded PVC cable protection* | | | | |
| GPT 30x30 L2600 | grounding conductors | 30 x 30 x 2600 | | 0.6 |
| GPC 35x35 L2750 | low voltage cables | 35 x 35 x 2750 | | 1.2 |
| GPC 60x60 L2750 | low voltage cables | 60 x 60 x 2750 | | 1.9 |
| GPC 90x90 L2750 | low/medium voltage cables | 90 x 90 x 2750 | | 2.6 |

* Standard colour is Gray. Colours of Ivory and Brown hue are available upon request.

NOTE Tools for steel straps see page 49.

Hooks, brackets and bolts for LV-ABC lines

Application

Anchor bracket CA xxxx:

made of aluminium alloy designed for main cables. To be mounted by 2 steel straps (20 mm) or up to 2 bolts (\varnothing 14 or 16 mm).



CA 1500, CA 2000

| Ordering description | Breaking load (kN) | Operating load (kN) | Weigth (kg/10pcs) |
|----------------------|--------------------|---------------------|-------------------|
| CA 1500-2 | 15.0 | 5.0 | 2.0 |
| CA 1500/2000 | 20.0 | 5.0 | 2.3 |

Application

Anchor bracket CAB 25:

made of stainless steel designed for service cables. To be mounted by a steel strap (20 mm), a bolt (\varnothing 14 or 16 mm) or 4 screws (\varnothing 5 mm).



CAB 25

| Ordering description | Breaking load (kN) | Operating load (kN) | Weigth (kg/10pcs) |
|----------------------|--------------------|---------------------|-------------------|
| CAB 25 | 2.0 | 0.8 | 0.2 |

Application

Hook plate HEL-5661:

made of galvanized steel designed for main cables. To be mounted to poles by 2 steel straps (20 mm). Breaking loads of min. 28 kN horizontal and 18 kN vertical.

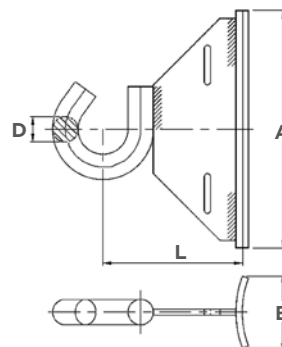

HEL-566

| Ordering description | A (mm) | B (mm) | L (mm) | D (mm) | Weigth (kg/pc) |
|----------------------|--------|--------|--------|--------|----------------|
| HEL-5661 | 150 | 45 | 82 | 16 | 0.8 |

Hooks, brackets and bolts for LV-ABC lines

Application

Spiral hooks, hook bolts, strain eye bolts

HEL-55xx:

made of hot-dip galvanized steel designed for main and service clamps. Fixed length by welded, flat or bended washers. Max. loads of spiral and bolt hook versions for bolt size of M16 (M20) are 5.5 (13) kN horizontal and vertical. Max. loads for strain eye versions for bolt size of M16 (M20) are 40 (40) kN horizontal and 7 (15) kN vertical.

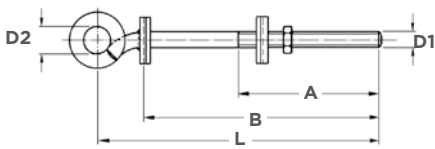

HEL-553x/4x

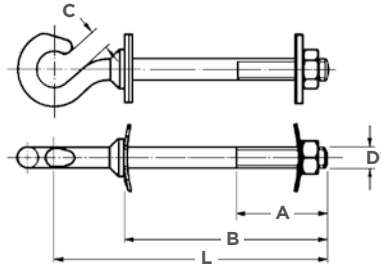

HEL-555x

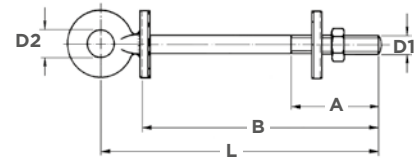

HEL-556x/7x

| Ordering description | A (mm) | B (mm) | L (mm) | D (mm) | D2/C (mm) | Weight (kg/pc) |
|-------------------------|--------|--------|--------|--------|-----------|----------------|
| Spiral hooks | | | | | | |
| HEL-5531 | 80 | 240 | 295 | M16 | 38 | 0.9 |
| HEL-5532 | 130 | 180 | 320 | M16 | 38 | 0.9 |
| HEL-5533 | 80 | 300 | 355 | M16 | 38 | 0.95 |
| HEL-5541 | 100 | 240 | 295 | M20 | 38 | 1.2 |
| HEL-5542 | 100 | 240 | 340 | M20 | 38 | 1.3 |
| HEL-5543 | 100 | 300 | 355 | M20 | 38 | 1.4 |
| Hook bolts | | | | | | |
| HEL-5551 | 80 | 240 | 300 | M16 | 32/17 | 0.72 |
| HEL-5552 | 80 | 300 | 380 | M16 | 32/17 | 0.84 |
| HEL-5556 | 100 | 240 | 300 | M20 | 32/21 | 1.1 |
| HEL-5557 | 100 | 380 | 420 | M20 | 32/21 | 1.3 |
| Strain eye bolts | | | | | | |
| HEL-5561 | 80 | 240 | 290 | M16 | 32 | 0.9 |
| HEL-5562 | 80 | 240 | 340 | M16 | 32 | 0.8 |
| HEL-5563 | 80 | 300 | 350 | M16 | 32 | 0.82 |
| HEL-5571 | 100 | 240 | 290 | M20 | 32 | 1.05 |
| HEL-5573 | 100 | 300 | 360 | M20 | 32 | 1.4 |

Hooks, brackets and bolts for LV-ABC lines

Application

Spiral hook BQC:

made of hot-dip galvanized steel designed for service clamps and max. operating loads of 2 kN horizontal and 0.4 kN vertical. Freely adjustable fixing length by 2 nuts.

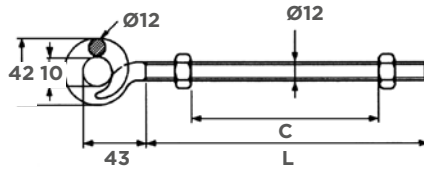

Type : BQC

| Ordering description | L (mm) | C _{max} (mm) | Weigth (kg/10pcs) |
|----------------------|--------|-----------------------|-------------------|
| BQC 12-55 | 55 | 45 | 1.8 |
| BQC 12-250 | 250 | 220 | 3.2 |
| BQC 12-300 | 300 | 270 | 3.6 |

Application

Spiral hook TQC 12-150:

made of hot-dip galvanized steel designed to anchor service dead end and suspension clamps to walls and max. operating loads of 2 kN horizontal and 0.4 kN vertical. Weight of 0.25 kg/pc, length L = 150 mm.

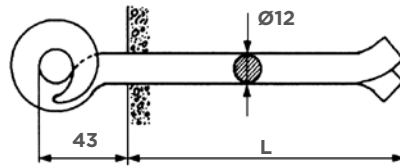

TQC 12-150

Application

Weak link hooks HEL-564x:

are used as hangers between the pole support fitting and the anchor or suspension clamp in areas where damage to the LV-ABC line could be expected from falling trees. Weak links withstand normal working loads but the controlled failure mechanism releases the cable in the event of overloads, enabling the cable to drop to the ground.

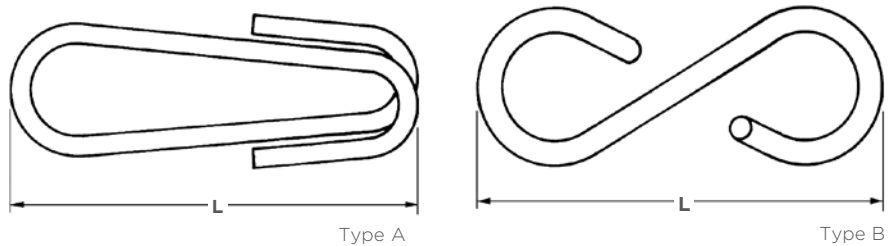

Type A

Type B

| Ordering description | Breaking load (kN) | L (mm) | C _{max} (mm) | Weigth (kg/10pcs) |
|----------------------|--------------------|--------|-----------------------|-------------------|
| HEL - 5641 | 4.0 + 1.2 - 0.4 | 90 | A | 0.8 |
| HEL - 5642 | 8.0 + 2.0 - 0.5 | 90 | B | 1.2 |

Application

Turnbuckle:

with closed eyes (22 mm) and an adjustable length of from 220 mm to 320 mm. Made of hot-dip galvanized steel with the eye thickness of 12 mm, breaking load of 8 kN and a weight of 0.6 kg/pc.

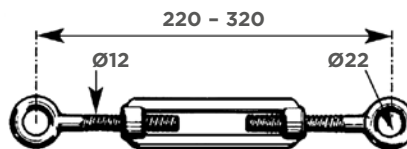

TC





Chapter V Installation tools and equipment

Tools and equipment for

| | |
|---|----|
| Setting up LV-ABC lines | 50 |
| Installation of stainless steel straps and cable ties | 52 |
| Connecting LV-ABC lines | 53 |
| Compression connection of LV-ABC lines..... | 54 |

Tools and equipment for setting up LV-ABC lines Cable grip components and assemblies

EMD 15

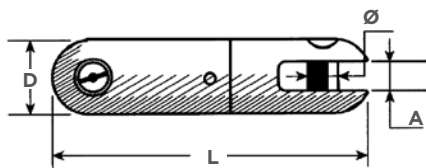
**Swivel EMD 15:**

Used with pulling socks to eliminate twist. Max. load 15 kN.

Dimensions (mm): D = 16, L = 122, \varnothing = 12, A = 16

TCSB, DUL-NLV

**Pulling socks TCSB, DUL-NLV:**

| Ordering description | CrossSection (mm ²) | Diameter (mm) | Length (mm) | Max. loach (kN) |
|--|---------------------------------|---------------|-------------|-----------------|
| For neutral messenger and ropes, made of galv. steel, single eyed | | | | |
| TCSB 15 | 54-70 | 10-15 | 500 | 5 |
| TCSB 20 | 95-120 | 15-18 | 500 | 5 |
| For protection of cables with neutral messenger, made of rilsan, single eyed | | | | |
| TCSB 38 | 3x70+54 | 30-38 | 750 | 5 |
| TCSB 50 | 3x150+70 | 40-50 | 900 | 5 |
| For self supporting cables, made of nylon strands, double soft eyes with alloy ferrules | | | | |
| DUL-NLV435 | 4x35 | 25±1 | 550 | 15 |
| DUL-NLV470 | 4x70 | 32±1 | 600 | 15 |
| DUL-NLV495 | 4x95 | 39±1 | 600 | 15 |
| DUL-NLV4150 | 4x150 | 44±1 | 600 | 15 |

ETC

**Complete cable grip assemblies ETC:**

for cables with insulated neutral messenger.

| Cross section (mm ²) | Ordering description | Components |
|----------------------------------|-----------------------------|------------------------------|
| ETC 70 | up to 3 x 70 + 54 | 2 x TCSB15 + TCSB 38 + EMD15 |
| ETC 150 | 3 x 70 + 54 to 3 x 150 + 70 | 2 x TCSB15 + TCSB 50 + EMD15 |

Stringing blocks and accessories



EDD 1000



PO 1000

Stringing block PO 1000:

consisting of plastic coated pulley and suspension hook.

Max. acceptable cable diameter: 50 mm

Max. load: 8 kN

Weight: 2.5 kg

Suspension assembly PO 1000 + SPC12 (=EDD 1000): consisting of stringing block and 1.2 m long strap.

Max. load: 15 kN

Weight: 5.2 kg



EDD 1700

**Stringing block EDD 1700:**

consisting of plastic coated pulley, suspension assembly and strap with clamping device.

Max. acceptable cable diameter: 50 mm

Max. load: 15 kN

Weight: 13.6 kg

Tools and equipment for setting up LV-ABC lines Pulling equipment

SCT

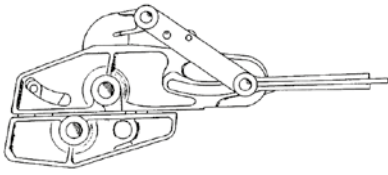

Pulling equipment SCT:

designed for LV-ABC lines with insulated neutral messenger. The lever automatically actuated converts the pulling force into a clamping force. The usage of the long aluminium jaws prevents damage to the aluminium or aluminium alloy cables.

| Ordering description | Cross Section (mm ²) | Diameter (mm) | Clamp Length (mm) | Load max. (kN) | Weight (kg/pc) |
|----------------------|----------------------------------|---------------|-------------------|----------------|----------------|
| SCT 13 | up to 54 | 6 – 13.5 | 160 | 8 | 1.6 |
| SCT 20 | 70 – 120 | 10 – 20 | 175 | 17 | 4.1 |

EM



Pulling equipment EM:

designed for self-supporting LV-ABC lines.

| Ordering description | Cross Section (mm ²) | Load max. (kN) | Weight (kg/pc) |
|----------------------|----------------------------------|----------------|----------------|
| EM35 | 2 x 25 – 35 + 4 x 16 -50 | 5.9 | 3.2 |
| EM5095 | 4 x 50 – 95 | 7.8 | 5.8 |
| EM95150 | 4 x 95 – 150 | 9.0 | 6.5 |

PTC

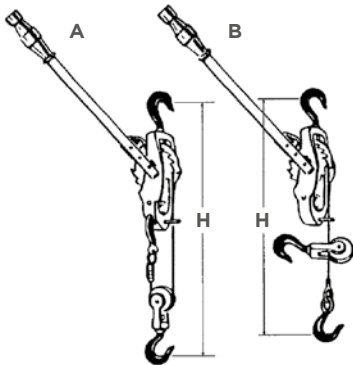

Lightweight cable hoist and pulling tool with hook pulley PTC:

for block or return, user-friendly handling by reversible lever with limited manual force (approx. 0.4 kN) and supporting reversible action.

| Ordering description | Hook setup A | | | Hook setup B | | | Weight |
|----------------------|----------------|--------------------|----------------|------------------|-----------|-----------|--------|
| | Load max. (kN) | Length H min. (mm) | Load max. (mm) | Length H (kg/pc) | | | |
| | | | | max (kN) | min. (mm) | max. (mm) | |
| PTC 750 | 7.5 | 560 | 2860 | 3.8 | 430 | 5030 | 4.3 |
| PTC 1000 | 10.0 | 550 | 2550 | 5.0 | 420 | 4420 | 4.2 |
| PTC 1600 | 16.0 | 660 | 3960 | 8.0 | 470 | 7070 | 6.2 |

DY

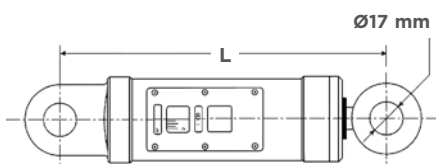

Dynamometer DY:

is lightweight and small with high accuracy (0.6 %) due to a spring washer system. No torsion or bending stresses permitted, use of swivel recommended.

| Ordering description | Load max. (kN) | Scale (kN) | (mm) | Travel max. (mm) | Length L (mm) | Weight (kg/pc) |
|----------------------|----------------|------------|------|------------------|---------------|----------------|
| DY 50 | 5 | 0.10 | 2.0 | 10 | 230 | 1.8 |
| DY 100 | 10 | 0.20 | 2.0 | 9 | 230 | 1.8 |
| DY 200 | 20 | 0.25 | 2.3 | – | 327 | 7.8 |

Tools for installation of stainless steel straps and cable ties

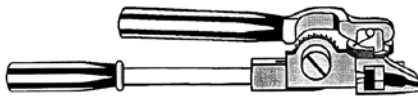
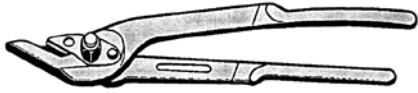

| Ordering description | Application |
|----------------------|--|
| OPC | Strap cutter |
| OPL | Ratchet type strap binding tool |
| OPV | Wheel type strap binding tool |
| Cable TY tool | Hand tool for bundling of heavy duty ties, user controlled tension and cut-off device, for cable ties of width from 6.0 to 9.0 mm. |

Tools for connecting LV-ABC lines



| Ordering description | Application |
|---|--|
| EXRM-0607 | Cable knife EXRM-0607 with fixed blade, length: 175 mm. |
| DCS BT | Insulation stripping tool DCS BT designed for LV-ABC cables from 16 mm ² up to 150 mm ² according to HD 626. |
| T-wrench IT-1000-022 fully insulated hexagon head for allen screws. | Width of allen screw across flats (mm) |
| IT-1000-022-4 | 4 |
| IT-1000-022-5 | 5 |
| IT-1000-022-6 | 6 |
| IT-1000-022-8 | 8 |
| Ratchet wrench CLESIM 2: | fully insulated for sockets for allen screw and hexagon bolt. |
| CLESIM 2 + RT5 | Ratchet wrench with socket for allen screw with 5 mm width across flats |
| CLESIM 2 + R10 | hexagon bolt with 10 mm width across flats |
| CLESIM 2 + R13 | hexagon bolt with 13 mm width across flats |
| SERSIM 2 | Carrying case SERSIM 2: includes one CLESIM 2 ratchet wrench and sockets RT5, R10 and R13. |
| KR 240 | Ratchet cable cutter KR 240 designed for both aluminium and copper conductors. For ordering description of fully insulated version use: KR 240 ISO. |
| Type of conductor | Application range of diameter (mm) |
| stranded | 6 – 32 |
| solid | 6 – 26 |
| FH-1630-S-TS1 | Torch assembly FH-1630-S-TS1 consists of a torch handle with holder and shut-off valve, a nozzle (38 mm) optimized for heat-shrink applications and a 5 m long pressure hose with DIN connection thread R 3/8" LH. |

Compression tools for connecting LV-ABC lines



| Ordering description | Features |
|------------------------|---|
| SIMPI | Manual compression tool SIMPI equipped with die E140, for cross sections up to 35 mm ² . HOLSTER SIMPI Holster for tool SIMPI, to be ordered separately. |
| SIMABLOC 55 | Manual operated, hydraulic compression tool SIMABLOC 55: designed for removable dies (type 4E and 5E) for cross sections up to 95 mm ² . Max. pressure force of 50 kN. SIMABLOC 55 + CR: Compression tool together with carrying case. |
| AUTOPRESS L55 | Battery operated, hydraulic compression tool AUTOPRESS L55: designed for removable dies (type 4E and 5E) for cross sections up to 95 mm ² . Max. pressure force of 50 kN. Supplied with carrying case, battery and 30' charger. |
| AUTOPRESS L62 | Battery operated, hydraulic compression tool AUTOPRESS L62: designed for removable dies (type 6E) for cross sections up to 150 mm ² . Max. pressure force of 62 kN. Supplied with carrying case, battery and 30' charger. |
| COFFRET SIMECA: | COFFRET SIMECA: Carrying case for tool SIMECA, to be ordered separately. |

Compression tools for connecting LV-ABC lines



| Ordering description | Features |
|----------------------|--|
| SIMABLOC 62 | SIMABLOC 62 designed for removable dies (type 4E and 5E) for cross sections up to 95 mm ² . Max. pressure force of 50 kN. Supplied together with carrying case. |
| SIMABLOC 80 | Manual operated, hydraulic compression tool SIMABLOC 80: designed for removable dies (type 7E) for cross sections up to 150 mm ² . Max. pressure force of 80 kN. SIMABLOC 80 + CR: Compression tool together with carrying case. |
| SIMABLOC C120 | Manual operated, hydraulic compression tool SIMABLOC C120: designed for removable dies (type 12SE) for cross sections up to 240 mm ² . Max. pressure force of 120 kN. SIMABLOC C120 + CR: Compression tool together with carrying case. |
| SIMABLOC U120 | Manual operated, hydraulic compression tool SIMABLOC U120: designed for removable dies (type 13UE) for cross sections up to 240 mm ² . Max. pressure force of 120 kN. SIMABLOC U120 + CR: Compression tool together with carrying case. |



Compression dies for connecting LV-ABC lines

Hexagonal compression dies according to NFC 33021 for aluminium and copper conductors

| Die code | Diameter (mm)/ Cross sections (mm ²) | Type of compression tool | | | | | |
|----------|--|--------------------------|---|---|--|---|---|
| | Load max. (kN) | SIMPI | SIMABLOC 55 AUTOPRESS L55 | SIMABLOC 80 SIMECA | SIMABLOC C120 | SIMABLOC U120 | AUTOPRESS L62 SIMABLOC 62 |
| | | |  |  |  |  |  |
| E140* | 16/ 4 – 35 | Included | 4E140-E83 | 7E173-E140 | 12SE140-9 | 13UE140-9 | 6E140-9 |
| E173 | 20/ 16 – 95 | - | 4E173 | 7E173-E140 | 12SE173-9 | 13UE173-9 | 6E173-9 |
| E215 | 25/ 120 – 150 | - | 5E215 | 7E215 | 12SE215-9 | 13UE215-9 | 6E215-9 |
| E280** | 32 / 240 | - | - | - | 12ASE280-18 | 13UE280-18 | 6E280-9 |

* Die code E140 typically for application on connectors' type of MJPB..., E173 and E215 for MJPT.

** Die code E280 typically for application on connectors' type of EJASE & XN8S.

NOTE Hexagonal compression dies according to DIN 48083 are available on request.



Appendix

Dimensions of LV-ABC cables according to HD 626

| | |
|---|-----------|
| Lines with insulated neutral messenger..... | 60 |
| Self-supporting lines..... | 61 |
| Lines with bare neutral messenger..... | 62 |
| Reference table..... | 63 |

Dimensions of LV-ABC lines with insulated neutral messenger according to HD 626

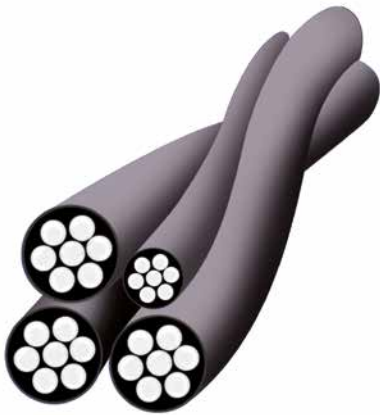

HD 626 S1: 1996
Part 6-Section E

Aluminium conductors with XLPE insulation, included in national products/standards: NF C 33029

Dimensions of phase conductors

| Cross section (mm ²) | Conductor diameter | | Nom. thickness of insulation (mm) | Core diameter | | Current carrying capacity (A*) | Breaking load (kN) |
|-------------------------------------|--------------------|-----------|---|---------------|-----------|--------------------------------------|--------------------------|
| | (mm) min. | (mm) max. | | (mm) min. | (mm) max. | | |
| 16 | 4.6 | 5.1 | 1.2 | 7.0 | 7.8 | – | – |
| 25 | 5.8 | 6.3 | 1.4 | 8.6 | 9.4 | 112 | – |
| 35 | 6.8 | 7.3 | 1.6 | 10.0 | 10.9 | 138 | – |
| 50 | 7.9 | 8.4 | 1.6 | 11.1 | 12.0 | 168 | – |
| 70 | 9.7 | 10.2 | 1.8 | 13.3 | 14.2 | 213 | – |
| 95 | 11.0 | 12.0 | 1.8 | 14.6 | 15.7 | 258 | – |
| 120 | 12.0 | 13.1 | 1.8 | 15.6 | 16.7 | 306 | – |
| 150 | 13.9 | 15.0 | 1.7 | 17.3 | 18.6 | 344 | – |

* Defined for ambient temperature of 30 °C and max. conductor temperature of 90 °C.

Dimensions of neutral messenger conductors

| Cross section (mm ²) | Conductor diameter | | Nom. thickness of insulation (mm) | Core diameter (mm) | | Current carrying capacity (A*) | Breaking load (kN) |
|-------------------------------------|--------------------|-----------|---|--------------------|------|--------------------------------------|-----------------------|
| | (mm) min. | (mm) max. | | min. | max. | | |
| 54.6 | 9.2 | 9.6 | 1.6 | 12.3 | 13.0 | – | 16.6 |
| 70 | 10.0 | 10.2 | 1.5 | 12.9 | 13.6 | – | 20.5 |
| 95 | 12.2 | 12.9 | 1.6 | 15.3 | 16.3 | – | 27.5 |

Dimensions of cable bundle

| Number of phase cores x cross section + public lighting conductors x cross section + neutral cross section (mm ²) | Bundle diameter Approx. (mm) |
|--|------------------------------------|
| 3 x 25 + 54.6 | 30.0 |
| 3 x 35 + K x 16 + 54.6 | 33.0 |
| 3 x 50 + K x 16 + 54.6 | 36.0 |
| 3 x 70 + K x 16 + 54.6 | 37.5 |
| 3 x 70 + K x 25 + 54.6 | 40.0 |
| 3 x 70 + K x 16 + 70 | 41.0 |
| 3 x 95 + K x 16 + 70 | 44.0 |
| 3 x 120 + K x 16 + 70 | 46.0 |
| 3 x 120 + K x 16 + 95 | 47.0 |
| 3 x 150 + K x 16 + 70 | 48.0 |
| 3 x 150 + K x 16 + 95 | 49.0 |

NOTE K number of public lighting conductors (K can be equal to 0, 1, 2, or 3)

Dimensions of self-supporting LV-ABC lines according to HD 626

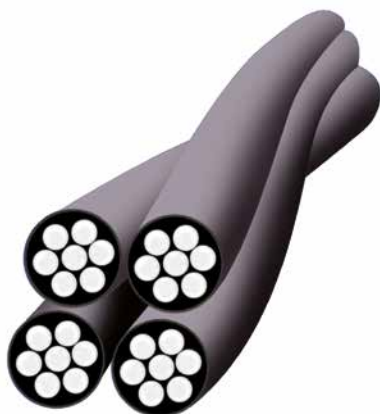

HD 626 S1: 1996
Part 4-Section F

Aluminium conductors with XLPE insulation, included in national products/standards: NFA2X (VDE 0276 - 626 4F-1), AsXS(n) (PL WT92/K396), 1-AES (CSN 34761-4F)

Dimensions of conductors

| Cross section (mm ²) | Conductor diameter | | Thickness of insulation | | Max core diameter (mm) | Current carrying capacity (A*) | Breaking load (kN) |
|-------------------------------------|--------------------|-----------|-------------------------|-----------|---------------------------|-----------------------------------|-----------------------|
| | (mm) min. | (mm) max. | (mm) nom. | (mm) min. | | | |
| 16 | 4.6 | 5.1 | 1.2 | 1.00 | 7.8 | – | 2.60 |
| 25 | 5.6 | 6.5 | 1.3 | 1.07 | 10.0 | 107 | 4.17 |
| 35 | 6.6 | 7.5 | 1.3 | 1.07 | 11.0 | 132 | 5.78 |
| 50 | 7.7 | 8.6 | 1.5 | 1.25 | 12.5 | 165 | 8.45 |
| 70 | 9.3 | 10.2 | 1.5 | 1.25 | 14.0 | 205 | 11.32 |
| 95 | 11.0 | 12.0 | 1.7 | 1.50 | 16.1 | – | 15.30 |
| 120 | 12.5 | 13.5 | 1.8 | 1.60 | 17.6 | – | 20.00 |
| 150 | 13.9 | 15.0 | 1.8 | 1.60 | 18.8 | – | 25.00 |

* Defined for ambient temperature of 35 °C and max. conductor temperature of 80 °C.

Dimensions of cable bundle

| Number of cores x cross section + public lighting conductors x cross section (mm ²) | Bundle diameter Approx. (mm) |
|---|------------------------------------|
| 2 x 16 | 15 |
| 2 x 25 | 18 |
| 2 x 35 | 20 |
| 4 x 16 | 18 |
| 4 x 25 | 22 |
| 4 x 35 | 25 |
| 4 x 50 | 28 |
| 4 x 70 | 32 |
| 4 x 70 + 1 x 35 | 36 |
| 4 x 70 + 2 x 35 | 40 |
| 4 x 95 | 37 |
| 4 x 120 | 40 |
| 4 x 120 + 2 x 35 | 43 |
| 4 x 150 | 44 |

Dimensions of LV-ABC lines with bare neutral messenger according to HD 626

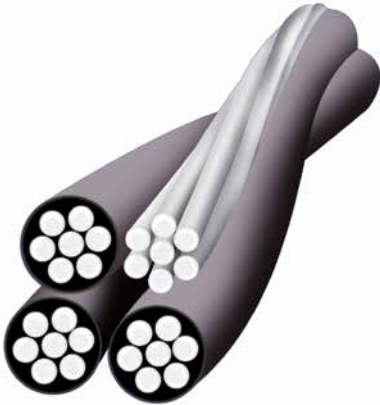

HD 626 S1: 1996
Part 5-Section D

Phase conductors with XLPE insulation, included in national products/standards:
AMKA (SFS 2200)

Dimensions of phase conductors

| Cross section (mm ²) | Conductor diameter (mm) | Nom. thickness of insulation (mm) | Core diameter | | Current carrying capacity (A*) | Breaking load (kN) |
|-------------------------------------|----------------------------|---|---------------|-----------|--------------------------------------|--------------------------|
| | | | (mm) min. | (mm) max. | | |
| 16 | 4.4 ± 0.05 | 1.4 | 7.1 | 7.3 | 70 | – |
| 25 | 5.9 ± 0.20 | 1.4 | 8.3 | 9.1 | 95 | – |
| 35 | 6.9 ± 0.20 | 1.6 | 9.7 | 10.5 | 115 | – |
| 50 | 8.1 ± 0.25 | 1.6 | 10.8 | 11.8 | 140 | – |
| 70 | 9.7 ± 0.25 | 1.8 | 12.8 | 13.8 | 180 | – |
| 120 | 12.8 ± 0.30 | 2.0 | 16.2 | 17.4 | 250 | – |

* Defined for ambient temperature of 25 °C and max. conductor temperature of 70 °C.

Dimensions of neutral messenger conductors

| Cross section (mm ²) | Conductor diameter (mm) | Nom. thickness of insulation (mm) | Core diameter (mm) | | Current carrying capacity (A*) | Breaking load (kN) |
|-------------------------------------|----------------------------|---|--------------------|------|--------------------------------------|-----------------------|
| | | | min. | max. | | |
| 25 | 5.9 ± 0.20 | – | 5.5 | 6.3 | – | 7.4 |
| 35 | 6.9 ± 0.20 | – | 6.5 | 7.3 | – | 10.3 |
| 50 | 8.1 ± 0.25 | – | 7.6 | 8.6 | – | 14.2 |
| 70 | 9.7 ± 0.25 | – | 9.2 | 10.2 | – | 20.6 |
| 95 | 11.4 ± 0.30 | – | 10.8 | 12.0 | – | 27. |

Dimensions of Cable Bundle

| Number of phase cores x cross section + neutral cross section (mm ²) | Bundle diameter Approx. (mm) |
|--|------------------------------------|
| 1 x 16 + 25 | 15 |
| 3 x 16 + 25 | 22 |
| 4 x 16 + 25 | 22 |
| 3 x 25 + 35 | 26 |
| 4 x 25 + 35 | 26 |
| 3 x 35 + 50 | 30 |
| 3 x 50 + 70 | 35 |
| 3 x 70 + 95 | 41 |
| 3 x 120 + 95 | 47 |

Reference Table

| Ordering description | Product number | Page |
|----------------------|----------------|--------|
| 102L011-R05/S(S100) | 381987N001 | 27 |
| 102L022-R05/S(S100) | 204645N001 | 27 |
| 102L033-R05/S(S100) | 059453N001 | 27 |
| 102L044-R05/S(S50) | 135907N001 | 27 |
| 102L048-R05/S(S25) | 286711N001 | 27 |
| 102L055-R05/S(S10) | 966649N001 | 27 |
| 102L066-R05/S(S10) | 252509N001 | 27 |
| 12SE140-9 | 037702-000 | 52 |
| 12SE173-9 | 916764-000 | 52 |
| 12SE215-9 | 306480-000 | 52 |
| 13UE140-9 | 458492-000 | 52 |
| 13UE173-9 | 027630-000 | 52 |
| 13UE215-9 | 371078-000 | 52 |
| 302K224/S(S20) | D45696N001 | 25 |
| 302K333/S(S20) | D93040N001 | 25 |
| 302K466/S(S10) | 127794N001 | 25 |
| 402W516/S(S5) | 337914N001 | 25 |
| 402W526/S(S5) | 000938N001 | 25 |
| 402W533/S(S10) | 096434N001 | 25 |
| 4E140-E83 | 733664-000 | 52 |
| 4E173 | 174974-000 | 52 |
| 502K016/S(S5) | C52918N001 | 25 |
| 502K026/S(S5) | C22917N001 | 25 |
| 502K033/S(S15) | E00553N001 | 25 |
| 502K046/S(S5) | 086694N001 | 25 |
| 502S013/S(S5) | CJ5843N001 | 25 |
| 5E215 | 889838-000 | 52 |
| 603W035/S(S5) | F40674N001 | 25 |
| 6E 140-9 | 1780012-1 | 52 |
| 6E 173-9 | 1727515-1 | 52 |
| 6E 215-9 | 1727516-1 | 52 |
| 6E 240-9 | 2107736-1 | 52 |
| 7E173-E140 | 074888-000 | 52 |
| 7E215 | 013694-000 | 52 |
| A 100 (box of 100) | 661424-000 | 42 |
| A 200 (box of 100) | 490298-000 | 42 |
| AUTOPRESS 55 | 895260-000 | 51 |
| AUTOPRESS L55 | 2107793-1 | 51 |
| AUTOPRESS L62 | 2107725-1 | 51 |
| BPC 35-35 | 577046-000 | 15 |
| BPC 35-P35 | 645308-000 | 15 |
| BPC P35-P35 | 006924-000 | 15 |
| BPC P50 | A26017-000 | 15 |
| BQC 12- 55 | 205796-000 | 44 |
| BQC 12-250 | 128208-000 | 44 |
| BQC 12-300 | 916070-000 | 44 |
| BRPF 1 | CP9306-000 | 41 |
| BRPF 6 | CP9308-000 | 41 |
| CA 1500/2000 | 118674-000 | 39, 43 |
| CA 1500-2 | E77297-000 | 38, 43 |
| CAB 25 | 119030-000 | 43 |
| CABLE TY TOOL | 707744-000 | 49 |
| CCFBD 6-6 | CN7805-000 | 30 |
| CCFBD 10-10 | CN7806-000 | 30 |
| CCFBD 16-16 | 109032-000 | 30 |
| CCFBD 25-25 | 630614-000 | 30 |
| CECT 16-150 | 332752-000 | 27 |
| CECT 6-35 | 416280-000 | 27 |

| Ordering description | Product number | Page |
|---------------------------|----------------|------|
| CLESIM2 + R10 | 012248-000 | 50 |
| CLESIM2 + R13 | 998826-000 | 50 |
| CLESIM2 + RT5 | 071272-000 | 50 |
| COFFRET SIMECA | 910812-000 | 51 |
| CPTA 35 | 432466-000 | 19 |
| CPTA 50 | 426682-000 | 19 |
| CPTA 54 | 414030-000 | 19 |
| CPTA 70 | 180178-000 | 19 |
| CPTA 95 D20 | 906826-000 | 19 |
| CPTA 150-21 D20UK | 438928-000 | 19 |
| CPTAU 16 D16 | 366520-000 | 19 |
| CPTAU 25 D16 | 623808-000 | 19 |
| CPTAU 35 (trousse) | 381500-000 | 19 |
| CPTAU 50 | 214368-000 | 19 |
| CPTAU 54 | 107112-000 | 19 |
| CPTAU 70 | 972344-000 | 19 |
| CPTAU 95 | 068480-000 | 19 |
| CPTAU 120 D25 | 797666-000 | 19 |
| CPTAU 150 D25 | 976758-000 | 19 |
| CRSM- 34/10- 250/239(B30) | 168551-000 | 28 |
| CRSM- 34/10- 500/239(B30) | 552273-000 | 28 |
| CRSM- 34/10-1000/239(S5) | 406345-000 | 28 |
| CRSM- 34/10-1500/239(B30) | 647565-000 | 28 |
| CRSM- 53/13- 250/239(B20) | 747669-000 | 28 |
| CRSM- 53/13- 500/239(B20) | 390635-000 | 28 |
| CRSM- 53/13- 750/239(B20) | 319783-000 | 28 |
| CRSM- 53/13-1000/239(S5) | 279727-000 | 28 |
| CRSM- 53/13-1500/239(B20) | 737881-000 | 28 |
| CS 922 | A22641-000 | 41 |
| CSB | 943840-000 | 41 |
| CSBF-C | 059518-000 | 41 |
| CSL 260 | 404082-000 | 41 |
| CSL 350 | 179554-000 | 41 |
| DCS BT | 367680-000 | 50 |
| DUL-NLV4150 | 999686-000 | 47 |
| DUL-NLV435 | 341580-000 | 47 |
| DUL-NLV470 | 375912-000 | 47 |
| DUL-NLV495 | 106124-000 | 47 |
| DY 50 | 450090-000 | 48 |
| DY 100 | 140196-000 | 48 |
| DY 200 | E13180-000 | 48 |
| DZ6 UL-F-CHINA-N | CP7938-000 | 11 |
| EA 1000 | CL0574-000 | 39 |
| EA 1500 | 891368-000 | 39 |
| EA 2000 | 157124-000 | 39 |
| EA 95-2000 | 611094-000 | 39 |
| EDD 1000 | F44394-000 | 47 |
| EDD 1700 | 064712-000 | 47 |
| EM35 | 420132-000 | 48 |
| EM5095 | 684460-000 | 48 |
| EM95150 | 768128-000 | 48 |
| EMD 15 | 266246-000 | 47 |
| EN-CGPT- 9/ 3-0-SP | C99919-000 | 26 |
| EN-CGPT-12/ 4-0-SP | F93007-000 | 26 |
| EN-CGPT-18/ 6-0-SP | C47829-000 | 26 |
| EN-CGPT-24/ 8-0-SP | F52163-000 | 26 |
| EN-CGPT-39/13-0-SP | E21457-000 | 26 |
| EN-DCPT- 6/ 3-45-SP | E44441-000 | 26 |

Reference Table

| Ordering description | Product number | Page |
|-----------------------|----------------|-----------|
| EN-DCPT-8/ 4-45-SP | A18953-000 | 26 |
| EN-DCPT-10/ 5-45-SP | A05941-000 | 26 |
| EN-DCPT-12/ 6-45-SP | A87683-000 | 26 |
| EN-DCPT-19/ 9-45-SP | F74998-000 | 26 |
| EN-DCPT-26/13-45-SP | E01829-000 | 26 |
| EN-DCPT-38/19-45-SP | C62205-000 | 26 |
| EP 35-13 | E84478-000 | 9 |
| EP 95-13 | D12469-000 | 9, 10, 11 |
| EP120-13 | F45314-000 | 9 |
| ES 35-1500 | D65834-000 | 40 |
| ES 95-2000 | CM1094-000 | 40 |
| ES 1500 25-95 | CM1094-000 | 40 |
| ESF 54/70 | D57874-000 | 40 |
| ETC 70 | 177438-000 | 47 |
| ETC 150 | 395180-000 | 47 |
| EXRM-0607 | 834686N001 | 50 |
| FH-1630-S-TS1 | 398323-000 | 50 |
| GelWrap-18/ 4-150(B6) | F90657-000 | 29 |
| GelWrap-18/ 4-200(B6) | F60655-000 | 29 |
| GelWrap-18/ 4-250(B6) | 971920-000 | 29 |
| GelWrap-33/10-150(B6) | E13495-000 | 29 |
| GelWrap-33/10-200(B6) | E86269-000 | 29 |
| GelWrap-33/10-250(B6) | A36570-000 | 29 |
| GelWrap-50/20-250 | D61559-000 | 29 |
| GelWrap-50/20-300 | 128958-000 | 29 |
| GPC 35x 35 L2750 | 926996-000 | 42 |
| GPC 60x 60 L2750 | 529784-000 | 42 |
| GPC 90x 90 L2750 | 495284-000 | 42 |
| GPT 30x 30 L2600 | 967294-000 | 42 |
| HEL-3005 | 277480-000 | 12 |
| HEL-3006 M6 | 833594-000 | 12 |
| HEL-3007 | 276812-000 | 12 |
| HEL-3009 | 339922-000 | 12 |
| HEL-3029 | 165998-000 | 12 |
| HEL-3030 | 821160-000 | 12 |
| HEL-3032 | 591368-000 | 12 |
| HEL-3587 | 927000-000 | 12 |
| HEL-3590 | 206428-000 | 12 |
| HEL-3591 | 705580-000 | 12 |
| HEL-3592 | 622662-000 | 12 |
| HEL-3594 | 437540-000 | 12 |
| HEL-3909 | 707352-000 | 12 |
| HEL-3911 | 580420-000 | 12 |
| HEL-3915 | 925876-000 | 12 |
| HEL-3919 | 429098-000 | 12 |
| HEL-3920 | 899310-000 | 12 |
| HEL-3929 | 169286-000 | 12 |
| HEL-3932 | 250760-000 | 12 |
| HEL-5503 | 331004-000 | 37 |
| HEL-5504 | 739014-000 | 37 |
| HEL-5505 | 099822-000 | 36, 37 |
| HEL-5505-2 | 524104-000 | 36 |
| HEL-5505-2B | D16382-000 | 36 |
| HEL-5505-B | F06256-000 | 36 |
| HEL-5506 | 705908-000 | 37 |
| HEL-5507 | 216760-000 | 37 |
| HEL-5531 | 519254-000 | 43 |
| HEL-5532 | 643444-000 | 43 |

| Ordering description | Product number | Page |
|----------------------|------------------|------|
| HEL-5533 | 010536-000 | 43 |
| HEL-5541 | 120454-000 | 43 |
| HEL-5542 | 112246-000 | 43 |
| HEL-5543 | 476152-000 | 43 |
| HEL-5551 | 028600-000 | 43 |
| HEL-5552 | 459014-000 | 43 |
| HEL-5556 | 124232-000 | 43 |
| HEL-5557 | 417333-000 | 43 |
| HEL-5561 | 165504-000 | 43 |
| HEL-5562 | 651772-000 | 43 |
| HEL-5571 | 932634-000 | 43 |
| HEL-5573 | 286826-000 | 43 |
| HEL-5574 | 326964-000 | 43 |
| HEL-5641 | 041256-000 | 44 |
| HEL-5642 | 029504-000 | 44 |
| HEL-5661 | E69028-000 | 43 |
| IT-1000-022-4 | C02524N001 | 50 |
| IT-1000-022-5 | F64441N001 | 50 |
| IT-1000-022-6 | C66493N001 | 50 |
| IT-1000-022-8 | F91843N001 | 50 |
| KR 240 | 977680-000 | 50 |
| KR 240-ISO | 870058-000 | 50 |
| KZ 2-150 2B | 296510-000 | 9 |
| KZ 2-150 2Bp | SIML-0-1229989-2 | 9 |
| KZ31-70 CNA | 898190-000 | 10 |
| KZ31-70 CNU | 773312-000 | 10 |
| MJPB 04-16 | 443396-000 | 16 |
| MJPB 06 | 430744-000 | 16 |
| MJPB 06-10 | 566234-000 | 16 |
| MJPB 06-16 | 531432-000 | 16 |
| MJPB 06-25 | 267858-000 | 16 |
| MJPB 06-35 | 150942-000 | 16 |
| MJPB 10 | 139412-000 | 16 |
| MJPB 10-16 | 267728-000 | 16 |
| MJPB 10-25 | 879526-000 | 16 |
| MJPB 10-35 | 248572-000 | 16 |
| MJPB 16 | 722174-000 | 16 |
| MJPB 16-25 | 170860-000 | 16 |
| MJPB 16-35 | 157846-000 | 16 |
| MJPB 25 | 985442-000 | 16 |
| MJPB 25-35 | 133268-000 | 16 |
| MJPB 35 | 083094-000 | 16 |
| MJPBAS 10-25M | 767146-000 | 16 |
| MJPBAS 10-35M | 211418-000 | 16 |
| MJPBAS 16-16M | 910170-000 | 16 |
| MJPBAS 16-25M | 170616-000 | 16 |
| MJPBAS 16-35M | 623852-000 | 16 |
| MJPBAS 25-16M | 281038-000 | 16 |
| MJPBAS 25-25M | 253722-000 | 16 |
| MJPBAS 25-35M | 173006-000 | 16 |
| MJPBAS 35-35M | 560160-000 | 16 |
| MJPT 16 | 061700-000 | 17 |
| MJPT 25 | 624876-000 | 17 |
| MJPT 25 Alus | 444410-000 | 17 |
| MJPT 35 | 756336-000 | 17 |
| MJPT 35 Alus | 702336-000 | 17 |
| MJPT 35-25 | F33216-000 | 17 |
| MJPT 50 | 887308-000 | 17 |

Reference Table

| Ordering description | Product number | Page |
|-------------------------|----------------|-----------|
| MJPT 50 Alus | 116574-000 | 17 |
| MJPT 50-25 | 819354-000 | 17 |
| MJPT 50-35 | 188754-000 | 17 |
| MJPT 54 | 529422-000 | 17 |
| MJPT 70 | 852608-000 | 17 |
| MJPT 70 Alus | 629804-000 | 17 |
| MJPT 70-35 | 597886-000 | 17 |
| MJPT 70-50 | 838510-000 | 17 |
| MJPT 70N | 510988-000 | 17 |
| MJPT 70N-54 | 516410-000 | 17 |
| MJPT 95 | 617184-000 | 17 |
| MJPT 95 Alus | 091314-000 | 17 |
| MJPT 95-35 | 958282-000 | 17 |
| MJPT 95-50 | 011820-000 | 17 |
| MJPT 95-70 | 304968-000 | 17 |
| MJPT 120 Alus | 245934-000 | 17 |
| MJPT 120 D25 | 452490-000 | 17 |
| MJPT 150 | 742002-000 | 17 |
| MJPT 150-70 | 723310-000 | 17 |
| MJPT 150-95 | 954578-000 | 17 |
| MT-206 | 943918-000 | 32 |
| MT-207 | on request | 32 |
| MT-245-CATU | 121578-000 | 32 |
| MWTM- 10/ 3-1000/S(S25) | 069816-000 | 26 |
| MWTM- 16/ 5-1000/S(S25) | 262852-000 | 26 |
| MWTM- 25/ 8-1000/S(S10) | 381522-000 | 26 |
| MWTM- 35/12-1000/S(S10) | 413206-000 | 26 |
| MWTM- 50/16-1000/S(S10) | 544794-000 | 26 |
| OPC | A52716-000 | 49 |
| OPL | 124996-000 | 49 |
| OPV | 525358-000 | 49 |
| P23 100 U Mk2 | 2107864-1 | 10 |
| P2X 95 Mk2 | CP2398-000 | 9, 10, 11 |
| P2X 150 | C41222-000 | 9 |
| P3B 120 | 2107862-1 | 10 |
| P3X 95 | C44216-000 | 9, 11 |
| P31 F | CX4230-000 | 9 |
| P4X 120D | C63836-000 | 9 |
| P4X 150D | F24596-000 | 9 |
| PA 4 120 | 633706-000 | 37 |
| PA 9-17/GALVA | 984632-000 | 35 |
| PA 95-2000 | 798946-000 | 39 |
| PA 1000 | C17546-000 | 39 |
| PA 1500x20 | 627106-000 | 39 |
| PA 2000 | 147388-000 | 39 |
| PA 25x100 | CM1503-000 | 35 |
| PAS 35 | 833418-000 | 35 |
| PMCC | 503916-000 | 31 |
| PO 1000 | E43464-000 | 47 |
| PS 35 | D56695-000 | 40 |
| PS 1500+LM 25-95 | CR2564-000 | 40 |
| PS 120 | 242194-000 | 40 |
| PS 250/435 | 606772-000 | 38 |
| PS 4120 | 206330-000 | 38 |
| PS 450 | 317482-000 | 38 |
| PS 470 | 883620-000 | 38 |
| PS 495 | 006072-000 | 38 |
| PTC 750 | 669578-000 | 48 |

| Ordering description | Product number | Page |
|---------------------------|----------------|------|
| PTC 1000 | 829060-000 | 48 |
| PTC 1600 | 579938-000 | 48 |
| PT-INOX-160/AA-1M | 983454-000 | 32 |
| RA 25 | 063830-000 | 35 |
| RF 1004 50M | CR2300-000 | 42 |
| RF 1007 50M | CR2301-000 | 42 |
| RF 2004 50M | CR2302-000 | 42 |
| RF 2007 50M | CR2303-000 | 42 |
| RONDELLE 30X10,5X2 -AL/CU | 957500-000 | 19 |
| RONDELLE 30X13X2 -AL/CU | 587654-000 | 19 |
| RSC 25-120 | CA7430-000 | 38 |
| SCT 13 | 664798-000 | 48 |
| SCT 20 | 457320-000 | 48 |
| SERSIM 2 | 886316-000 | 50 |
| SIMABLOC 55 | 264562-000 | 51 |
| SIMABLOC 55+CR | 245242-000 | 51 |
| SIMABLOC 80 | 008590-000 | 51 |
| SIMABLOC 80+CR | 205076-000 | 51 |
| SIMABLOC C120 | 055956-000 | 51 |
| SIMABLOC C120+CR | 289542-000 | 51 |
| SIMABLOC U120 | 182184-000 | 51 |
| SIMABLOC U120+CR | A55347-000 | 51 |
| SIMPI | 901858-000 | 51 |
| SMOE-82281(S10) | CN2290-000 | 22 |
| SMOE-82282(S10) | CN2288-000 | 22 |
| SMOE-82283(S10) | CN2292-000 | 22 |
| SMOE-82284(S10) | CN2293-000 | 22 |
| SMOE-82285(S10) | CN2313-000 | 22 |
| SMOE-82286(S10) | CN2314-000 | 21 |
| SMOE-82287(S10) | CN2320-000 | 21 |
| SMOE-82288(S10) | CN2321-000 | 21 |
| TCSB 15 | 720544-000 | 47 |
| TCSB 20 | CM7038-000 | 47 |
| TCSB 38 | 027296-000 | 47 |
| TCSB 50 | 002788-000 | 47 |
| TENDEUR TC | 301538-000 | 47 |
| TQC 12-150 | E67232-000 | 47 |
| USC 25-120 | CM1971-000 | 38 |

TE Connectivity (NYSE: TEL) is a \$12 billion global technology leader. Our connectivity and sensor solutions are essential in today's increasingly connected world. We collaborate with engineers to transform their concepts into creations – redefining what's possible using intelligent, efficient and high-performing TE products and solutions proven in harsh environments. Our 72,000 people, including over 7,000 engineers, partner with customers in close to 150 countries across a wide range of industries. We believe EVERY CONNECTION COUNTS – www.TE.com.

- Mining
- Nuclear power plants
- OEMs
- Overhead distribution
- Petrochemical plants
- Railways
- Street lighting
- Substations
- Transmission lines
- Underground distribution
- Windfarms
- Solar
- Hydro-electric

WHEREVER ELECTRICITY FLOWS, YOU'LL FIND TE ENERGY



te.com/energy

FOR MORE INFORMATION:

TE Technical Support Centers

| | | | |
|----------|--------------------|---------------------|--------------------|
| France: | + 33 380 583 200 | Italy: | + 39 333 2500 915 |
| Germany: | + 49 896 089 903 | Poland and Baltics: | + 48 224 576 753 |
| UK: | + 44 8 708 707 500 | Czech Republic: | + 42 0 272 011 105 |
| Spain: | + 34 916 630 400 | Sweden and Norway: | + 46 850 725 000 |
| Benelux: | + 32 16 351 731 | Middle East: | + 971 4 2 117 000 |
| Denmark: | + 45 43 480 424 | USA: | + 1 800 327 6996 |

te.com/energy

© 2016 TE Connectivity Ltd. family of companies. All Rights Reserved. EPP-0874-6/16

GelWrap, TE, TE Connectivity and the TE connectivity (logo) are trademarks of the TE Connectivity Ltd. family of companies. Other logos, product and Company names mentioned herein may be trademarks of their respective owners. While TE has made every reasonable effort to ensure the accuracy of the information in this brochure, TE does not guarantee that it is error-free, nor does TE make any other representation, warranty or guarantee that the information is accurate, correct, reliable or current. TE reserves the right to make any adjustments to the information contained herein at any time without notice. TE expressly disclaims all implied warranties regarding the information contained herein, including, but not limited to, any implied warranties of merchantability or fitness for a particular purpose. The dimensions in this brochure are for reference purposes only and are subject to change without notice. Specifications are subject to change without notice. Consult TE for the latest dimensions and design specifications.

